

DESIGNAZIONE
DESIGNATION
DESIGNATION

B2-B15

Size	Nm		
10	1000	B18	B19
20	2000	B20	B21
25	2500	B22	B23
30	3000	B24	B25
40	4000	B26	B27
50	5000	B28	B29
70	7000	B30	B31
80	8000	B32	B33
90	9000	B34	B35
100	10000	B36	B37
150	15000	B38	B39
180	18000	B40	B41
200	20000	B42	B43
250	25000	B44	B45
280	28000	B46	B47
300	30000	B48	B49
350	35000	B50	B51
420	48000	B52	B53
650	65000	B54	B55
850	85000	B56	B57
1200	120000	B58	B59

SCHEDE TECNICHE RIDUTTORI
GEARBOXES TECHNICAL SHEETS
TECHNISCHE DATENBLAETTER GETRIEBE

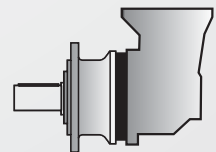
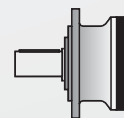

1.1 Designazione

1.1 Designation

1.1 Bezeichnung

EX **B** **10** **1** **-** **P** **D**

CODE:
Example of Order

Maschine	Centerline Orientation	Size	N° of reductions	Combined gearbox	Output Version	Output Shaft
00-M	01-CO	02-SIZE	03-NOR	04-CG	05-OV	06-OS

WEB:
Reference Designation

1-2
3-4
EXV
"63-70-85-110"

Small
10-20-25-30-40
50-70-80-90-100

Hight
150-180-200-250-280
300-350-420-650-850
1200

R M-MX T P FCB FP FS FB N; D; E; C; U

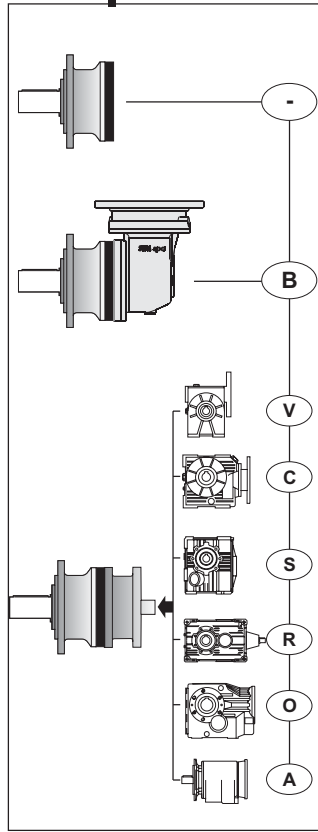
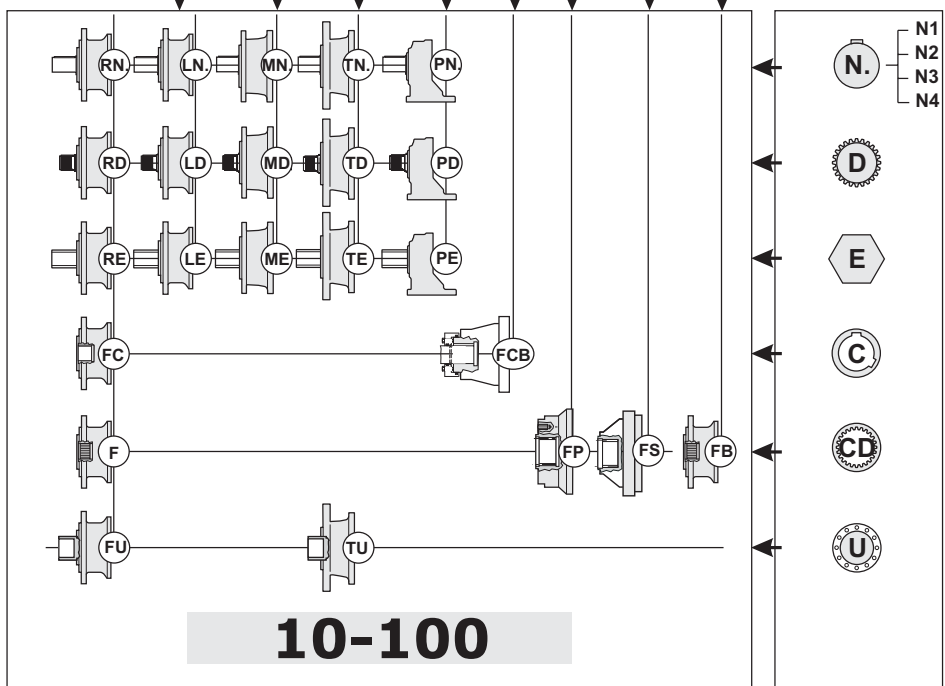

R T H-X S-SB PH-PX PS-PSB P FCB FS N; D; E; C; U

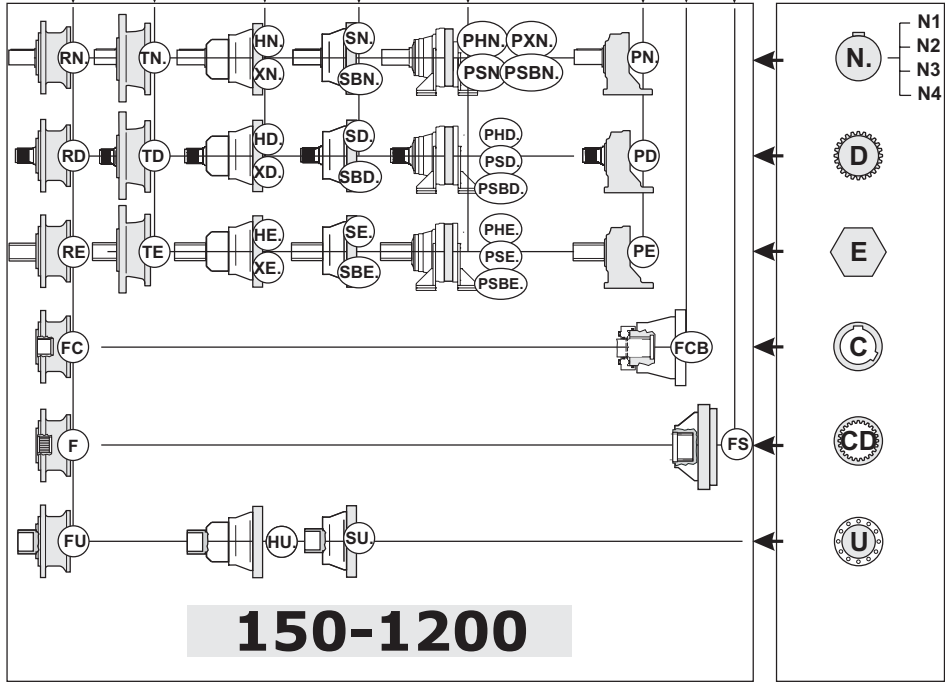

1.1 Designazione

1.1 Designation

1.1 Bezeichnung

63.4 **Z** **1** **A** **1** **-** **CA04** **-** **VT** **A** **M11** **FD** **-**

Reduction ratio	Type Brake	Size Brake	Static Torque Brake	Attachment Brake	Input Version	Input Shaft	IEC type and Input Shaft	Options	Mounting Version	Mounting positions	Accessories	Position Terminal Box
07-IR	8a-TBZ	8b-SIZEBZ	8c-STBZ	8d-ABZ	09-IV	10-IS	11-IECT	13-OPT	14-MV	15-MP	16-ACC	17-PMT

3.60; 4.25; 5.33; ...

-; G; D

VT

A-B-C-D
L-M-N-O

1-Standard
2-3-4

EX:
P: M1-M2-M3-M4-M5-M6
R-M-H-FB-FS-FP: M1-M3-M4

EXB
EXV;EXC;EXS;EXR;EXO;EXA:
P: M11-M12-M13-M14
M21-M22-M23-M24
M35-M46-M36-M45
M51-M52-M53-M54
M61-M62-M63-M64
R-M-H-FB-FS-FP: M11-M12-M13-M14
M35-M46-M36-M45

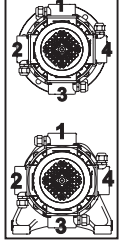

Z. PR EU ECE ECR I IEC 1A; 2A.; CA04.; 63; 71.

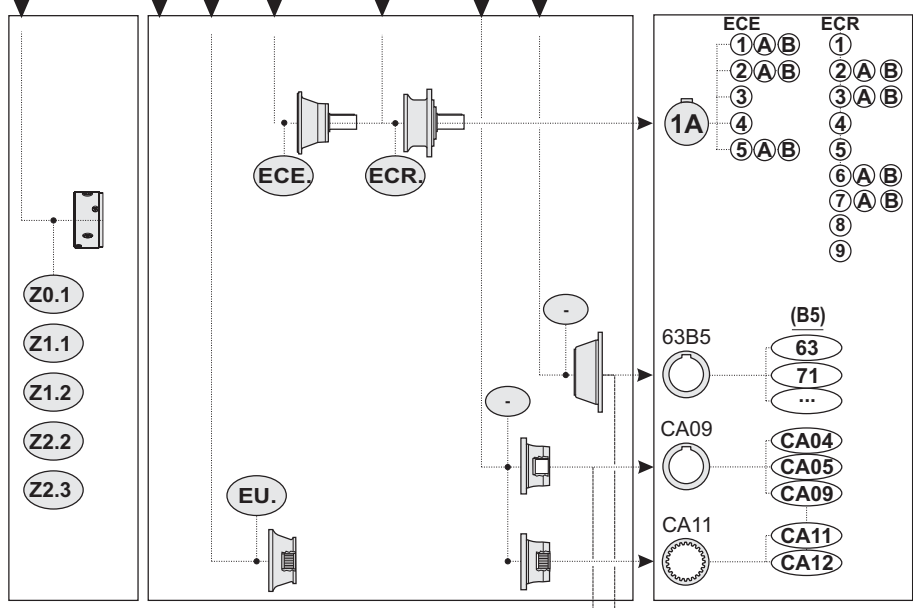

ACC1

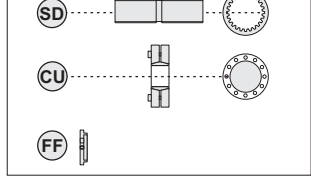

ACC2

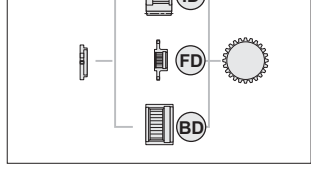

ACC3



ACC4



ACC5

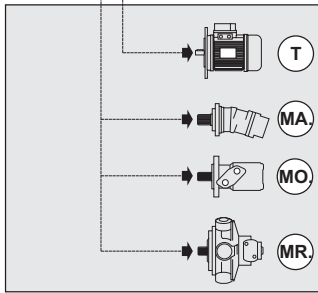

B

1.1 Designazione

1.1 Designation

1.1 Bezeichnung

00 M - Macchina

M - Maschine

M - Getriebe

EX

01 CO - Posizione Assi

CO - Centerline Orientation

CO - Bauform getriebestufen

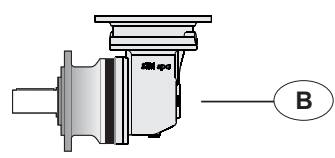
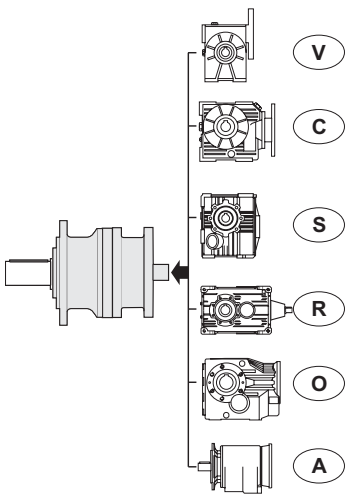
	01-CO	
	Lineare In line Linear	
	Ortogonale Bevelgear Kegelgetriebe	
	V	Ortogonale / Bevelgear / Kegelgetriebe
	C	Ortogonale / Bevelgear / Kegelgetriebe
	S	Ortogonale / Bevelgear / Kegelgetriebe
	R	Ortogonale / Bevelgear / Kegelgetriebe
	O	Ortogonale / Bevelgear / Kegelgetriebe
A	Lineare / In line / Linear	

02 SIZE - Grandezza

SIZE - Size

SIZE - Größe

10	20	25	30	40	50	70	80	90	100	150	180	200	250	280	300	350	420	650	850	1200
----	----	----	----	----	----	----	----	----	-----	-----	-----	-----	-----	-----	-----	-----	-----	-----	-----	------

03 NOR - N° Stadi

NOR - N° of reductions

NOR - N° Anzahl der stufen

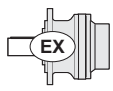
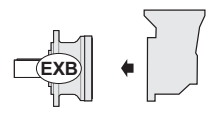
	02 SIZE	10	20	25	30	40	50	70	80	90	100	150	180	200	250	280	300	350	420	650	850	1200
	03 NOR	1-2-3-4			2-3 4		1-2-3-4			2-3 4		1-2-3-4		2-3 4		1-2-3-4						
	02 SIZE	10	20	25	30	40	50	70	80	90	100	150	180	200	250	280	300	350	420	650	850	1200
	03 NOR	2-3-4			3-4		2-3-4			3-4		2-3-4		3-4				4				

1.1 Designazione

1.1 Designation

1.1 Bezeichnung

04 CG- Riduttore Accoppiato

CG - Combined gearbox

CG - Kombiniertes Getriebe

	1								2								3								4							
10	101								102								103							104								
20		201							202								203							204								
25		251							252								253							254								
30			301						302								303							304								
40									402								403							404								
50				501					502								503							504								
70					701				702								703							704								
80						801			802								803							804								
90									902								903							904								
100							1001		1002								1003							1004								
150								1501	1502								1503							1504								
180									1802								1803							1804								
200									2001								2003							2004								
250									2501								2503							2504								
280																	2803							2804								
300									3001								3003							3004								
350																	3503							3504								
420																	4203							4204								
650																	6503							6504								
850																								8504								
1200																								1200						1200		
																								3						4		

B

EXV 50																														
EXV 63																														
EXV 70																														
EXV 85																														
EXV 110																														
EXV 130																														
EXV 150																														
EXV 180																														
EXC 50																														
EXC 70																														
EXC 85																														
EXC 110																														
EXS 35																														
EXS 45																														
EXR 704																														
EXR 708																														
EXR 712																														
EXR 716																														
EXR 720																														
EXO 132																														
EXO 150																														
EXO 170																														
EXO 190																														
EXA 35																														
EXA 41																														
EXA 45																														
EXA 50																														

1.1 Designazione

1.1 Designation

1.1 Bezeichnung

05 OV - Versione Uscita

OV - Output Version

OV - Abtriebsausführung

06 OS - Albero Uscita

OS - Output Shaft

OS - Abtriebswelle



	10 20 25	30 40 50 70	80	90 100	150 180 200	250 280	300	350 420	650	850	1200
RN1	ø38xL58	ø60xL105	ø80xL130	ø90xL170	ø90xL170						
RN2	ø42xL82	ø65xL105		ø100xL170	ø100xL170						
RN3	ø50xL82	ø50xL100									
RN4	ø48xL82										
RD	B 40x36	B 58x53	B 70x64	B 80x74	B 80x74						
MN1	ø60xL105	ø60xL105	ø80xL130								
MN2	ø65xL105	ø65xL105									
MN3	ø50xL100										
MD	B 58x53	B 58x53	B 70x64								
MXN1		ø60xL105									
MXN2		ø65xL105									
MXD		B 58x53									
TN1	ø38xL58	ø60xL105	ø80xL130	ø90xL170	ø90xL170	ø 110xL210	ø 120xL210				
TN2	ø42xL82	ø65xL105		ø100xL170	ø100xL170						
TN3	ø50xL82	ø50xL100									
TN4	ø48xL82										
TD	B 40x36	B 58x53	B 70x64	B 80x74	B 80x74	B 100x94	W 120x3				
HN1					ø90xL170	ø 110xL210	ø 120xL210				
HN2					ø100xL210						
HD					B 80x74	B 100x94	W 120x3				
XN1											
XN2					ø100xL210						
XD					B 100x94						
SN1								ø 120xL210	ø 160xL240	ø 170xL240	ø 180xL240
SN2								ø 140xL220			
SD								W 120x3	W150x5	W170x5	W 170x5
SBN1								ø 120xL210			
SBN2								ø 140xL220			
SBD								W 120x3			



	10 20 25	30 40 50 70	80	90 100	150 180 200	250 280	300	350 420	650	850	1200
PN1	ø38xL58	ø60xL105	ø80xL130	ø90xL170	ø 90xL170						
PN2	ø42xL82	ø65xL105			ø100xL210						
PN3	ø50xL82										
PN4	ø48xL82										
PD	B 40x36	B 58x53	B 70x64	B 80x74	B 80x74						
PHN1					ø90xL170	ø 110xL210	ø 120xL210				
PHN2					ø100xL210						
PHD					B 80x74	B 100x94	W 120x3				
PXN1											
PXN2					ø100xL210						
PXD					B 100x94						
PSN1								ø 120xL210	ø 160xL240	ø 170xL240	
PSN2								ø 140xL220			
PSD								W 120x3	W150x5	W170x5	
PSBN1								ø 120xL210			
PSBN2								ø 140xL220			
PSBD								W 120x3			

1.1 Designazione

1.1 Designation

1.1 Bezeichnung

05 OV - Versione Uscita

OV - Output Version

OV - Abtriebsausführung

06 OS - Albero Uscita

OS - Output Shaft

OS - Abtriebswelle

	10 20 25	30 40 50 70	80	90 100	150 180 200	250 280	300	350 420	650	850	1200
F	A 40x36	A 58x53	A 70x64	A 80x74							
FB			A 70x64	A 70x64							
FP		A 58x53									
FS	A 40x36	A 58x53*	A 70x64*	A 80x74*	A 80x74	A 100x94	N 120x5	EX 350 N 120x3	N 150x5	N 170x5	N 200x5
FSB								EX 420 N 140x5			

B



	10 20 25	30 40 50 70	80	90 100	150 180 200	250 280	300	350 420	650	850	1200
FC	ø 35	ø 50	ø 65	ø 75							
FCB		ø 65	ø 80*	ø 90*	ø 100	ø 110					

(*) NOTA
Solo per **EXB**
- Non disponibili per le grandezze
10-20-25-30-40-50-70-80-90-100:
le versioni **FS-FCB**.

(*) NOTA
Only for **EXB**
- Not available for size
10-20-25-30-50-70-80-90-100:
versions **FS-FCB**.

(*) NOTA
Nur für **EXB**
- Nicht verfügbar für Größe
10-20-25-30-40-50-70-80-90-100:
die Ausführungen **FS-FCB**



	10 20 25	30 40 50 70	80	90 100	150 180 200	250 280	300	350 420	650	850	1200
FU	ø 50	ø 75	ø 90	ø 100	ø 120						
HU					ø 120	ø 130	ø 135				
SU								ø 145	ø 165	ø 180	ø 220
TU					ø 120	ø 130	ø 135				

07 IR- Rapporto di riduzione

IR - Reduction ratio

IR - Übersetzungsverhältnis

(Vedi prestazioni). Tutti i valori dei rapporti sono approssimati. Per applicazioni dove necessita il valore esatto consultare il ns. servizio tecnico.

(See ratings). Ratios are approximate values. If you need exact values for a specific application, please contact our Engineering.

(Siehe "Leistungen"). Bei allen Werten der Übersetzungen handelt es sich um approximative Wertangaben. Bei Applikationen, bei denen die exakte Wertangabe erforderlich ist, muss unser Technischer Kundendienst konsultiert werden.



1.1 Designazione

1.1 Designation

1.1 Bezeichnung

Descrizione Predisposizione Adjustment description Beschreibung Vorbereitung	08a	08b	08c								08d	09-IV 10-IS
Freno Idraulico Hydraulic Brake Lamellen Bremsen	TBZ Tipo Type	SIZEBZ Grandezza Size Größe	STBZ Coppia Frenatura Static Torque Mittleres Stützmoment								ABZ Accoppiamento Attachment Verbindung	
Z.	Z	0	A	B	C	D	E	F	G	H	1 (10)	CA04 CA05 CA06 ...
		1	60 Nm	100 Nm	160 Nm	200 Nm	280 Nm	330 Nm	430 Nm	520 Nm	1 (10-20-25) 2 (30-50-70)	
		2	90 Nm	140 Nm	240 Nm	300 Nm	430 Nm	550 Nm	—	—	2 (30-50-70) 3 (80-100)	

Per Dimensioni e Predisposizioni disponibili vedere Sezione D / See section D for adjustments and dimensions available / Für Abmessungen und mögliche Vorbereitungen siehe Sektion

10- IS Albero Entrata Input Shaft Antriebswelle				EX 101→ 1001				EX 102→3502 EXB 102→1002				EX 103→12003 EXB 103→3503				EX-EXB 104→12004			
10				101				102				103				104			
20					201				202				203				204		
25					251				252				253				254		
30						301			302				303				304		
40									402				403				404		
50						501			502				503				504		
70						701			702				703				707		
80							801			802			803				804		
90										902			903				904		
100						1001				1002			1003				1004		
150										1502			1503				1504		
180										1802			1803				1804		
200										2002			2003				2004		
250											2502			2503			2504		
280											2802			2803			2804		
300											3002			3003			3004		
350											3502			3503			3504		
420														4203			4204		
650															6503			6504	
850															8503			8504	
1200															12003			12004	
	D	R	G																
Z0				Z0.				Z0.				Z0.				Z0.			
CA 04	25	106.4	82.6	1				1				1				1			
CA 05	25.4	106.4	82.6																
CA 09	1" 6B	106.4	82.6																
Z1				Z1.	Z1.	Z1.		Z1.	Z1.	Z1.		Z1.	Z1.	Z1.		Z1.	Z1.	Z1.	
CA 04	25	106.4	82.6	1	1	2		1	1	2		1	1	2		1	1	2	
CA 09	1" 6B	106.4	82.6																
CB 07	32	106.4	82.6																
DA 11	12/24-12	125	100																
DB 22	N30x2	125	100																
FA 13	12/24-16	160	125																
FA 22	N30x2	160	125																
FA 23	N35x2	160	125																
FA 24	N40x2	160	125																
FA 28	N32x2	160	125																
FB 08	40	160	125																
PA 29	28x34	210	175																
Z2				Z2.	Z2.			Z2.	Z2.			Z2.	Z2.3			Z2.			
FA13	12/24-16	160	125	2	3			2	3			2			2				
FA24	N40x2	160	125																
HB24	N40x2	180	140																
KB24	N40x2	200	160																
LA25	N45x2	224	180																
OA31	36x40	250	150																



1.1 Designazione

1.1 Designation

1.1 Bezeichnung

09 IV - Versione Entrata

IV - Input Version

IV - Antriebsausführung

10 IS - Albero Entrata

IS - Input Shaft

IS - Antriebswelle

Descrizione Predisposizione Adjustment description Beschreibung Vorbereitung	09 IV	10 IS	Note Remarks Merkmale
Senza Flangia Motore Beschreibung Vorbereitung Ohne Motorenflansch	PR	-	EX. Combinati . EX. Combined Gearbox. EX Kombiniert.
Universale Universal	EU	-	Per Dimensioni e Predisposizioni disponibili vedere Sezione D
Albero maschio cilindrico con linguetta Support with keyed cylindrical shaft Vollwelle mit Passfeder	ECE	1A 2A 3 ...	See section D for adjustments and dimensions available Fuer Abmessungen und moegliche Vorbereitungen siehe Sektion D

B

10 - IS Albero Entrata Input Shaft Antriebswelle	EX2 EXB2		EX3 EXB3		EX4 EXB4	
	EX 101→1001	EX 102→ 3502 EXB102→ 1002	EX 103→ 12003 EXB103→ 3503	EX-EXB 104→ 12004		
10	101	102	103	104		
20	201	202	203	204		
25	251	252	253	254		
30	301	302	303	304		
40		402	403	404		
50	501	502	503	504		
70	701	702	703	704		
80	801	802	803	804		
90		902	903	904		
100	1001	1002	1003	1004		
150		1502	1503	1504		
180		1802	1803	1804		
200		2002	2003	2004		
250		2502	2503	2504		
280		2802	2803	2804		
300		3002	3003	3004		
350		3502	3503	3504		
420			4203	4204		
650			6503	6504		
850			8503	8504		
1200			12003	12004		
	D	L	R	G		
EU	50x45	150	95			
ECE 1A	24	50				
ECE 1B						
ECE 2A	38	58				
ECE 2B						
ECE 3	42	82				
ECE 4	48	82				
ECE 5A	28	50				
ECE 5B						

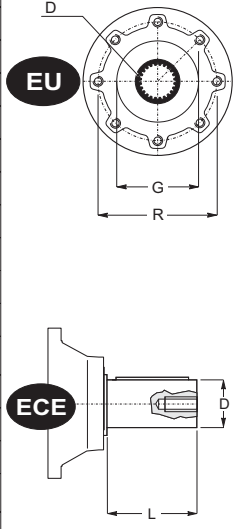



1.1 Designazione

1.1 Designation

1.1 Bezeichnung

- 09 IV - Versione Entrata
- 10 IS - Albero Entrata

- IV - Input Version
- IS - Input Shaft

- IV - Antriebsausführung
- IS - Antriebswelle

Descrizione Predisposizione Adjustment description Beschreibung Vorbereitung	09 IV	10 IS	Note Remarks Merkmale
Albero maschio cilindrico con linguetta - Rinforzata Reinforced support with keyed cylindrical shaft Vollwelle mit verstaerkter Passfeder	ECR	1 2 3 ...	Per Dimensioni e Predisposizioni disponibili vedere Sezione D See section D for adjustments and dimensions available Fuer Abmessungen und moegliche Vorbereitungen siehe Sektion D

10 - IS Albero Entrata / Input ShaftAntriebswelle	D	L	R	G
ECR0	42	82	165	110
ECR1	50	82	165	110
ECR2A-ECR2B	60	105	195	150
ECR3A-ECR3B	65	105	195	150
ECR4	65	105	245	175
ECR5	80	130	250	200
ECR6A	90	170	295	230
ECR6B	100	170	295	230
ECR7A	90	170	295	230
ECR7B	100	170	295	230
ECR8	110	210	370	245
ECR9	120	210	370	245

EX 101 → 3001					EX 102 → 8502					EX 103 → 12003					EX-EXB 104 → 12004				
10	101				102					103				104					
20	201				202					203				204					
25	251				252					253				254					
30		301			302					303				304					
40					402					403				404					
50		501			502					503				504					
70		701			702					703				704					
80			801			802				803				804					
90						902				903				904					
100				1001		1002				1003				1004					
150				1501		1502				1503				1504					
180						1802				1803				1804					
200				2001		2002				2003				2004					
250					2501		2502				2503			2504					
280							2802				2803			2804					
300							3001		3002		3003			3004					
350									3502		3503			3504					
420									4202		4203			4204					
650										6502			6503				6504		
850											8502			8503				8504	
1200													12003					12004	
ECR0																			
ECR1																			
ECR2A																			
ECR2B																			
ECR3A																			
ECR3B																			
ECR4																			
ECR5																			
ECR6A																			
ECR6B																			
ECR7A																			
ECR7B																			
ECR8																			
ECR9																			

1.1 Designazione

1.1 Designation

1.1 Bezeichnung

09 IV - Versione Entrata

IV - Input Version

IV - Antriebsausführung

10 IS - Albero Entrata

IS - Input Shaft

IS - Antriebswelle

Descrizione Predisposizione Adjustment description Beschreibung Vorbereitung	09 IV	10 IS	Note Remarks Merkmale
Motore Elettrico-IEC Elektromotor-IEC Electric motor-IEC	IEC	63 71 80 ...	Per Dimensioni e Predisposizioni disponibili vedere Sezione D See section D for adjustments and dimensions available Für Abmessungen und mögliche Vorbereitungen siehe Sektion D

10- IS Albero Entrata Input Shaft Antriebswelle																
	101	201	251	301	102	202	252	302	103	203	253	303	104	204	254	304
10																
20																
25																
30																
40																
50																
70																
80																
90																
100																
150																
180																
200																
250																
280																
300																
350																
420																
650																
850																
1200																

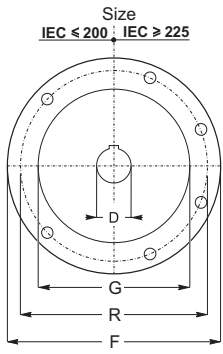

	D	F	R	G												
63	11	140	115	95												
71	14	160	130	110												
80	19	200	165	130												
90	24	200	165	130												
100	28	250	215	180												
112	28	250	215	180												
132	38	300	265	230												
160	42	350	300	250												
180	48	350	300	250												
200	55	400	350	300												
225	60	450	400	350												
250	65	550	500	450												
280	75	550	500	450												

B



1.1 Designazione

1.1 Designation

1.1 Bezeichnung

09 IV - Versione Entrata

IV - Input Version

IV - Antriebsausführung

10 IS - Albero Entrata

IS - Input Shaft

IS - Antriebswelle

Descrizione Predisposizione Adjustment description Beschreibung Vorbereitung	09 IV	10 IS	Note Remarks Merkmale
Motore Elettrico-IEC Elektromotor-IEC Electric motor-IEC	IEC	63 71 80 ...	Per Dimensioni e Predisposizioni disponibili vedere Sezione D See section D for adjustments and dimensions available Fuer Abmessungen und moegliche Vorbereitungen siehe Sektion D

10- IS Albero Entrata Input Shaft Antriebswelle														
10		102				103				104				
20		202				203				204				
25		252				253				254				
30		302				303				304				
40		-				403				404				
50			502				503				504			
70			702			703				704				
80				802		803				804				
90				-		903				904				
100				1002			1003			1004				
150							1503			1504				
180							1803			1804				
200							2003			2004				
250								2503		2504				
280								2803			2804			
300							3003			3004				
350							3503			3504				
420										4204				
650											6504			
850												8504		
1200												12004		

	D	F	R	G									
63	11	140	115	95									
71	14	160	130	110									
80	19	200	165	130									
90	24	200	165	130									
100	28	250	215	180									
112	28	250	215	180									
132	38	300	265	230									
160	42	350	300	250									
180	48	350	300	250									
200	55	400	350	300									
225	60	450	400	350									
250	65	550	500	450									
280	75	550	500	450									



1.1 Designazione

09 IV - Versione Entrata

10 IS - Albero Entrata

1.1 Designation

IV - Input Version

IS - Input Shaft

1.1 Bezeichnung

IV - Antriebsausführung

IS - Antriebswelle

Descrizione Predisposizione Adjustment description Beschreibung Vorbereitung	09 IV	10 IS	Note Remarks Merkmale
Motore Idrraulico Hydromotor Hydraulic motor		CA04 CA05 CA06 ...	Per Dimensioni e Predisposizioni disponibili vedere Sezione D See section D for adjustments and dimensions available Fuer Abmessungen und moegliche Vorbereitungen siehe Sektion D

10 - IS - Albero Entrata Input Shaft Antriebswelle	EX 101→ 1001	EX 102→ 3502		EX 103→ 12003		EX-EXB 104→ 12004	
		EXB 102→ 1002		EXB 103→ 3503			
10							
20							
25							
30							
40							
50							
70							
80							
90							
100							
150							
180							
200							
250							
280							
300							
350							
420							
650							
850							
1200							

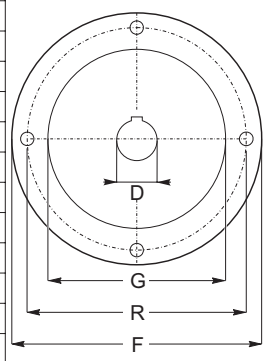

	D	R	G																	
BA 21	N25x1,25	100	80																	
CA 04	25	106,4	82,6																	
CA 05	25,4	106,4	82,6																	
CA 06	31,75	106,4	82,6																	
CA 09	1" 6B	106,4	82,6																	
CA 11	12/24-12	106,4	82,6																	
CA 12	12/24-14	106,4	82,6																	
CA 15	16/32-13	106,4	82,6																	
CB 07	32	106,4	82,6																	
DB 04	25	125	100																	
DA 11	12/24-12	125	100																	
DB 21	N25x1,25	125	100																	
DB 22	N30x2	125	100																	
EA 15	16/32-13	146	101,6																	
FA 13	12/24-16	160	125																	
FA 22	N30x2	160	125																	
FA 23	N35x2	160	125																	
FA 24	N40x2	160	125																	
FA 28	N32x2	160	125																	
FB 08	40	160	125																	
FB 14	12/24-17	160	125																	
GAB 17	16/32-21	162 181	127																	
GC 08	40	162	127																	
HA 10	10/20-16	180	140																	
HB 23	N35x2	180	140																	
HB 24	N40x2	180	140																	
JA 20	8/16-13	228,6	152,4																	
KB 22	N30x2	200	160																	
KB 24	N40x2	200	160																	
LA 25	N45x2	224	180																	
LB 33	45	224	180																	
NA 29	28x34	160	125																	
OA 31	36x40	250	150																	
PA 29	28x34	210	175																	

1.1 Designazione

1.1 Designation

1.1 Bezeichnung

11 IECT - Tipo IEC e Albero Entrata

IECT - IEC type and Input Shaft

IECT - IEC Typ und Antriebswelle

11 IECT	Descrizione	EX EXB	EX.					
			Combinato / Combined / Kombiniert					
			EXV	EXC	EXS	EXR	EXA	EXO
-	Con campana senza giunto Motor bell without coupling mit Glocke ohne Kupplung					RXP - RXO 704 - 708 712 - 716		-
G	Con giunto With coupling mit Kupplung		50 - 63		35 - 45	RXP - RXO 704 - 708 712 - 716	2C - 41 2C - 45	*
D	Accoppiamento diretto Direct coupling direkte Passung		50 - 63 70 - 85 110 - 130 150 - 180	50 - 70 85 - 110		RXO 704 - 708 712 - 716	35 3C - 41 3C - 45 50	*

- * Contattare nostro ufficio tecnico commerciale
- * Please, contact our technical sales dept.
- * Bitte setzen Sie sich mit unserer technischen Abteilung in Verbindung

13 OPT - Opzioni - Materiale degli anelli di tenuta

OPT - Options - Materials of Seals

OPT - Optionen - Dichtungstoffe

	Tenute STANDARD	Oil Seals Standard	Ölabdichtungen Standard
-			
VT1	Paraoli in viton in entrata	Viton oil seals at input end	Ölabdichtungen aus Viton im Antrieb
VT2	Paraoli in viton in uscita	Viton oil seals at output end	Ölabdichtungen aus Viton im Abtrieb
VT	Paraoli in viton in entrata ed in uscita	Viton oil seals at input and output end	Ölabdichtungen aus Viton im An- und Abtrieb

Vedi Sezione E.

To see section E.

Sie in der Sektion E.

14 MV - Versione di Montaggio

MV - Mounting Version

MV - Montagausführung

APPLICABILITA': solo per prodotti combinati esempio EXB-EXV - EXC - EXS - EXR - EXO - EXA.
La versione di montaggio definisce la posizione reciproca del riduttore EX con il riduttore combinato.
Lo schema grafico è riportato nella Sezione V.

Applicability: only for combined gearboxes type EXB - EXV - EXC - EXS - EXR - EXO and EXA.
The mounting position define the mountin position between the two gearboxes.
The graphic sketch is to the section V.

Anwendung: nur für kombinierte Getriebe Typen EXB - EXV - EXC - EXS - EXR - EXO - EXA.
Die Montageversion zeigt die Position beider Getriebe.
Die Grafische Ausfuehrung finden Sie in der Sektion V.

Lato flangia uscita riduttore combinato Combined gearbox output flange side Montageseite Abtriebsflansch für kombinierte Getriebe	Descrizione Description Beschreibung	EX.						
		Combinato / Combined / Kombiniert						
		EXB	EXV	EXC	EXS	EXR	EXO	EXA
DX	flangia destra Right flange Flansch rechts	A - B - C - D						
SX	flangia sinistra Left flange Flansch links	-			L - M - N - O			-



EXB

Tipo Supporto Uscita / Output support type / Abtriebselement

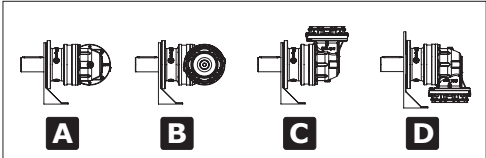
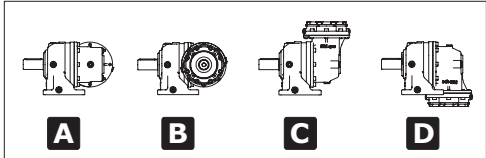
Con Flangia-With Flange-Mit Flansch (Example output version R.)	Con piede - With foot - Mit Fuß (Example output version P.)
A - B - C - D	A - B - C - D
	

1.1 Designazione

1.1 Designation

1.1 Bezeichnung

15 MP - Posizioni di montaggio

MP - Mounting positions

MP - Einbaulagen

Dopo aver definito la versione di montaggio è necessario che sia indicata la posizione in cui il riduttore sarà montato.

After to have defined the mounting position it's necessary to show the position whose the gearbox will be mounted.

Nachdem die Einbaulage mitgeteilt wurde, muessen auch die Positionen der 2 Getriebe definiert werden.

Il primo numero indica la posizione di montaggio in cui si viene a trovare il riduttore EX mentre il secondo numero la posizione in cui si trova il riduttore combinato.

The first number is the EX mounting position while the second number is the combined gearbox position.

Die erste Nummer ist die Einbaulage des EX Getriebe, die zweite das kombinierte Getriebe. Bitte das Oe dementsprechend fuellen.

Attenersi a questi indicazioni per il riempimento dei rispettivi riduttori.

Follow this instructions for to fill the gearboxes.

Die Grafische Ausfuehrung finden Sie in der Sektion V.

Lo schema grafico è riportato nella Sezione V.

On the section V there is the graphic sketch.

B

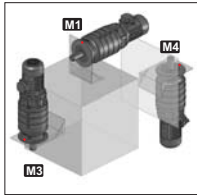
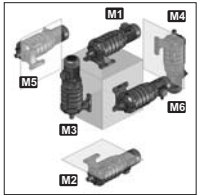
EX	
Tipo Supporto Uscita / Output support type / Abtriebselement	
Con Flangia-With Flange-Mit Flansch (Example output version R.)	Con piede - With foot - Mit Fuß (Example output version P.)
M1-M2-M3	M1-M2-M3-M4-M5-M6
	

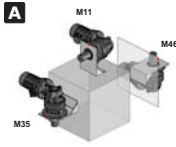
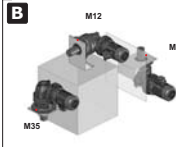
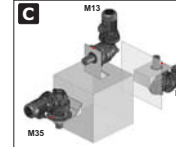
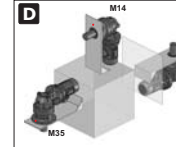
EXB			
Tipo Supporto Uscita / Output support type / Abtriebselement			
Con Flangia-With Flange-Mit Flansch (Example output version R.)			
M11-M35 -M46 (MV=A)	M12-M35 -M46 (MV=B)	M13-M35 -M46 (MV=C)	M11-M35 -M46 (MV=D)
A 	B 	C 	D 

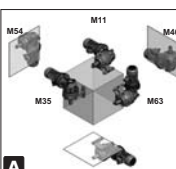
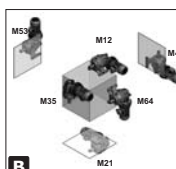
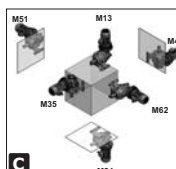
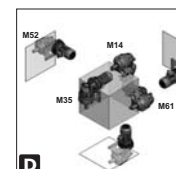
EXB			
Tipo Supporto Uscita / Output support type / Abtriebselement			
PIEDE (Tipo P...)			
M11-M22 -M35-M46-M54-M63(MV=A)	M12-M21 -M35-M46-M53-M64(MV=B)	M13-M24 -M35-M46-M51-M62(MV=C)	M14-M23 -M35-M46-M52-M61(MV=D)
A 	B 	C 	D 

EX. (Combinato / Combined / Kombiniert)		
Tipo Supporto Uscita / Output support type / Abtriebselement	P.	R - M - H - FB - FS - FP
Designazione / Designation / Bezeichnung	M11 - M21 - M35 - M51 - M61 M12 - M22 - M46 - M52 - M62 M13 - M23 - M36 - M53 - M63 M14 - M24 - M45 - M54 - M64	M11 - M12 - M13 - M14 M35 - M46 - M36 - M45

Lo schema grafico è riportato nella Sezione V / On the section V there is the graphic sketch / Die Grafische Ausfuehrung finden Sie in der Sektion V

16 ACC. - Accessori

ACC. - Accessories

ACC. - Zubehör

16a ACC1		Accessori -Estremità uscita / Accessories - Output Configuration / Zubehör - Enden der Ausgangswellen		
Code	Descrizione	Description	Beschreibung	
SD	Barra scanalata - SD	Splined - SD	mit Keilende - SD	
CU	Unità di bloccaggio	Shrink disc	Schrumpfscheibe	
FF	KIT - Fondello - FF	Kit - Cover -FF	KIT - Deckel - FF	
Vedi Sezione C / To see section C / Sie in der Sektion C				

16b ACC2		Accessori - Estremità Dentate D / Accessories - Output Configuration - Accessories - Splined D / Zubehör - Enden der Ausgangswellen mit Keilende D		
Code	Descrizione	Description	Beschreibung	
ID.	Pignone dentato	Output pinions	Abtriebsitzel	
FD	Estremità scanalata albero lento flangia brocciata	Splined output shaft and broached flange	Abtriebswelle mit Keilende und geräumtem Flansch	
BD	Bussola dentata	BUSHING	BUCHSE	
Vedi Sezione C / To see section C / Sie in der Sektion C				

ID. OP - Pignoni dentati

OP - Output pinions

OP - Abtriebsritzel

Modulo Normale Normal module Normales Modul		Numero Denti Number of Teeth Zahneanzahl		Larghezza Fascia Teeth width Zahnbreite		Coefficiente di Spostamento Addendum modification coefficient Profilverschiebungsfaktor	
Modulo Module Modul	Designazione Designation Bezeichnung	N° Denti Teeth nr. Zaehne Nr.	Designazione Designation Bezeichnung	Larghezza Fascia Widht Zahnbreite	Designazione Designation Bezeichnung	Designazione Designation Bezeichnung	X=(+ or - real value)
4.5	A	10	10	40-49	A	1...9	
5	B	11	11	50-59	B		
6	C	12	12	60-69	C		
8	D	13	13	70-79	D		
10	E	14	14	80-89	E		
12	F	15	15	90-99	F		
14	G	16	16	100-109	G		
16	H	17	17	110-119	H		
18	I	18	18	120-129	I		
20	L	19	19	130-139	L		
		20	20	140-149	M		
		21	21	150-159	N		
				160-169	O		
				170-179	P		
				180-189	Q		
				190-199	R		
				200-209	S		
				210-219	T		
				220-229	U		
				230-239	V		
				240-249	W		
				250-259	X		
				260-269	Y		
				270-279	Z		

Esempio:
Se si vuole un pignone dentato per rotazione con modulo normale 16, numero denti 21, larghezza fascia 146 e coefficiente di spostamento di profilo di + 0.5 in designazione si dovrà riportare:
ID H21M6 X+0.5

For example:
If you require a rotation pinion with normal module 16, teeth number 21, width 146 and addendum modification coefficient +0.5 the description will be:

ID H21M6 X+0.5

Z. B. Wenn Sie einen Ritzel fuer Drehung mit normalen Modul 16, Zahneanzahl 21, Breite 146 und Profilverschiebungsfaktor +0.5 benoetigen, wird die Beschreibung folgend sein:

ID H21M6 X+0.5

16 ACC. - Accessori

ACC. - Accessories

ACC. - Zubehör

16c ACC3		Accessori - Versioni pendolari / Accessories - Shaft Mounted Version - Zubehör - Aufsteckausführung		
Code	Descrizione	Description	Beschreibung	
 BRD	Braccio Reazione Doppio	Torque arm - Double	Drehmomentstütze - Doppel	
 BRS	Braccio Reazione Semplice	Torque arm - Single	Drehmomentstütze - Normal	
Vedi Sezione C / To see section C / Sie in der Sektion C				

16d ACC4		Accessori - Vaso Espansione / Accessories - Expansion tank / Zubehör - Expansionsfäß		
Code	Descrizione	Description	Beschreibung	
 OT.	Vaso espansione - ...litri	Expansion tank - ...l	Expansionsfäß - ,,l	
Vedi Sezione E / To see section E / Sie in der Sektion E				

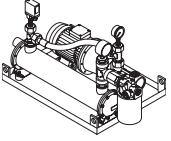
16e ACC5		Accessori - sistema con scambiatore / Accessories - Cooling Unit / Zubehör - Kühlanlage		
Code	Descrizione	Description	Beschreibung	
 RFA.	RFA. - sistema con scambiatore aria-olio	RFA. - air/oil exchanger	RFA. - System mit Luft-/Ölaustauscher	
 RFW.	RFW. - sistema con scambiatore acqua-olio	RFW. - water/oil exchanger	RFW. - System mit Wasser-/Ölaustauscher	
Vedi Sezione E / To see section E / Sie in der Sektion E				

17 PMT - Posizioni della Morsettiera

PMT - Position Terminal Box

PMT - Montagposition Klemmenkasten

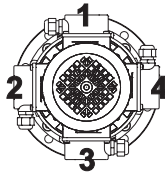
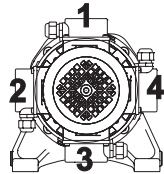
Tipo Supporto Uscita / Output support type / Abtriebselement	
Con Flangia-With Flange-Mit Flansch (Example output version R.)	Con piede - With foot - Mit Fuß (Example output version P.)
	

[2, 3, 4] Posizione della morsettiera del motore se diversa da quella standard (1).
Vedi Sezione C e V.

[2, 3, 4] Position of the motor terminal box if different from the standard one (1).
To see section C and V.

Montageposition Klemmenkasten [2, 3, 4], wenn abweichend von Standardposition [1] (für Motorgetriebe).
Sie in der Sektion C und V.

1.2 Prestazioni

1.2 Performances

1.2 Leistungen

EX 	n ₂ X h								10000 Hours Life				T _{max} [Nm]
	Stadio Stage Stufe	ir	T _N [Nm]						n ₁ [rpm]	n ₂ [rpm]	T _N [Nm]	P ₁ [kW]	
10000			20000	50000	100000	500000	1000000	2000000					
1	3,48	1076	1025	957	906	750	609	495	1400	402	401	17,26	1833
	4,26	1022	972	955	942	737	598	486		328	419	14,70	1750
	5,77	939	889	802	723	551	521	472		243	445	11,55	1417
	7,20	665	595	514	460	369	342	317		194	318	6,60	1083
2	12,11	1076	1025	957	906	750	609	495	1400	116	584	7,36	1833
	14,84	1022	972	955	942	737	598	486		94	609	6,27	1750
	18,17	1022	972	955	942	737	598	486		77	647	5,44	1750
	20,08	1076	1025	957	906	750	609	495		70	679	5,17	1833
	24,60	1022	972	955	942	737	598	486		57	709	4,40	1750
	30,69	1022	972	955	942	737	598	486		46	757	3,77	1750
	33,28	939	889	802	723	551	521	472		42	558	2,56	1417
	41,54	939	889	802	723	551	521	472		34	568	2,09	1417
51,84	665	595	514	460	369	342	317	27	395	1,16	1083		
3	51,63	1022	972	955	942	737	598	486	1400	27	861	2,60	1750
	63,25	1022	972	955	942	737	598	486		22	877	2,16	1750
	69,87	1076	1025	957	906	750	609	495		20	890	1,99	1833
	77,48	1022	972	955	942	737	598	486		18	893	1,80	1750
	85,59	1022	972	955	942	737	598	486		16	933	1,70	1750
	104,85	1022	972	955	942	737	598	486		13	937	1,39	1750
	106,82	1022	972	955	942	737	598	486		13	937	1,37	1750
	130,86	1022	972	955	942	737	598	486		11	941	1,12	1750
	141,90	1022	972	955	942	737	598	486		10	942	1,04	1750
	144,55	1076	1025	957	906	750	609	495		10	909	0,98	1833
	177,09	1022	972	955	942	737	598	486		7,9	946	0,83	1750
	180,40	1076	1025	957	906	750	609	495		7,8	925	0,80	1833
	221,00	1022	972	955	942	737	598	486		6,3	950	0,67	1750
239,64	939	889	802	723	551	521	472	5,8	784	0,51	1417		
299,08	939	889	802	723	551	521	472	4,7	810	0,42	1417		
4	220,10	1022	972	955	942	737	598	486	1400	6,4	950	0,69	1750
	243,14	1076	1025	957	906	750	609	495		5,8	947	0,62	1833
	269,63	1022	972	955	942	737	598	486		5,2	954	0,56	1750
	303,44	1076	1025	957	906	750	609	495		4,6	963	0,51	1833
	364,89	1022	972	955	942	737	598	486		3,8	960	0,42	1750
	403,08	1076	1025	957	906	750	609	495		3,5	984	0,39	1833
	447,00	1022	972	955	942	737	598	486		3,1	963	0,34	1750
	493,79	1022	972	955	942	737	598	486		2,8	965	0,31	1750
	557,86	1022	972	955	942	737	598	486		2,5	967	0,28	1750
	627,80	1076	1025	957	906	750	609	495		2,2	1017	0,26	1833
	818,63	1022	972	955	942	737	598	486		1,7	975	0,19	1750
	942,17	1022	972	955	942	737	598	486		1,5	939	0,16	1750
	1021,64	1022	972	955	942	737	598	486		1,4	956	0,15	1750
	1275,01	1022	972	955	942	737	598	486		1,1	1002	0,13	1750
	1591,22	1022	972	955	942	737	598	486		0,9	1049	0,10	1750
	1725,44	939	889	802	723	551	521	472		0,8	969	0,09	1417
	2153,35	939	889	802	723	551	521	472		0,7	1000	0,07	1417
2687,39	665	595	514	460	369	342	317	0,5	738	0,04	1083		

P _{TN}	P	R-L-F-FC-FU FB-FCB	M MX	FS FP
101	18.6	12.6	14.1	11.7
102	12.2	8.7	9.6	8.2
103	8.0	6.0	6.5	5.7
104	6.7	5.2	5.5	4.9

1.2 Prestazioni

1.2 Performances

1.2 Leistungen

		n ₂ X h							10000 Hours Life				T _{max} [Nm]
		T _N [Nm]							n ₁ [rpm]	n ₂ [rpm]	T _N [Nm]	P ₁ [kW]	
Stadio Stage Stufe	ir	10000	20000	50000	100000	500000	1000000	2000000					
2	10,01	1076	1025	957	906	750	609	495	1400	140	551	8,68	1833
	12,26	1022	972	955	942	737	598	486		114	575	7,02	1750
	16,59	939	889	802	723	551	521	472		84	528	5,02	1417
	17,76	1022	972	955	942	737	598	486		79	643	5,70	1750
	20,70	665	595	514	460	369	342	317		68	357	2,72	1083
	24,04	939	889	802	723	551	521	472		58	544	3,57	1417
	29,23	941	880	807	807	737	598	486		48	746	4,02	1750
	39,56	939	889	802	723	551	521	472		35	566	2,26	1417
	49,37	665	595	514	460	369	342	317		28	392	1,25	1083
3	34,82	1076	1025	957	906	750	609	495	1400	40	801	3,71	1833
	42,65	1022	972	955	942	737	598	486		33	836	3,16	1750
	52,25	1022	972	955	942	737	598	486		27	862	2,66	1750
	61,82	1022	972	955	942	737	598	486		23	875	2,28	1750
	70,71	1022	972	955	942	737	598	486		20	886	2,02	1750
	75,73	1022	972	955	942	737	598	486		18	891	1,90	1750
	88,25	1022	972	955	942	737	598	486		16	934	1,71	1750
	102,48	1022	972	955	942	737	598	486		14	936	1,47	1750
	119,42	939	889	802	723	551	521	472		12	706	0,95	1417
	127,89	1022	972	955	942	737	598	486		11	940	1,18	1750
	168,65	1022	972	955	942	737	598	486		8,3	945	0,90	1750
	210,48	1022	972	955	942	737	598	486		6,7	950	0,73	1750
	284,84	939	889	802	723	551	521	472		4,9	804	0,45	1417
4	148,43	1022	972	955	942	737	598	486	1400	9,4	943	1,0	1750
	181,84	1022	972	955	942	737	598	486		7,7	947	0,85	1750
	215,12	1022	972	955	942	737	598	486		6,5	950	0,72	1750
	222,76	1022	972	955	942	737	598	486		6,3	951	0,70	1750
	246,07	1022	972	955	942	737	598	486		5,7	952	0,63	1750
	263,53	1022	972	955	942	737	598	486		5,3	954	0,59	1750
	301,45	1022	972	955	942	737	598	486		4,6	956	0,52	1750
	322,84	1022	972	955	942	737	598	486		4,3	957	0,48	1750
	376,21	1022	972	955	942	737	598	486		3,7	960	0,42	1750
	407,95	1022	972	955	942	737	598	486		3,4	962	0,38	1750
	445,07	1022	972	955	942	737	598	486		3,1	963	0,35	1750
	509,12	1022	972	955	942	737	598	486		2,7	966	0,31	1750
	545,24	1022	972	955	942	737	598	486		2,6	967	0,29	1750
	591,23	1022	972	955	942	737	598	486		2,4	969	0,27	1750
	635,38	1022	972	955	942	737	598	486		2,2	970	0,25	1750
	737,85	1022	972	955	942	737	598	486		1,9	973	0,21	1750
	897,30	1022	972	955	942	737	598	486		1,6	929	0,17	1750
	972,99	1022	972	955	942	737	598	486		1,4	972	0,16	1750
	1214,30	1022	972	955	942	737	598	486		1,2	992	0,13	1750
	1515,44	1022	972	955	942	737	598	486		0,9	1038	0,11	1750
2050,81	939	889	802	723	551	521	472	0,7	993	0,08	1417		

P _{TN}	P	R-L-F-FC-FU FB-FCB	M MX	FS FP
102	11,6	9,4	9,9	9,0
103	8,6	7,1	7,5	6,9
104	6,8	5,7	5,9	5,5

1.2 Prestazioni

1.2 Performances

1.2 Leistungen

EX 	n ₂ X h								10000 Hours Life				T _{max} [Nm]
	Stadio Stage Stufe	ir	T _N [Nm]						n ₁ [rpm]	n ₂ [rpm]	T _N [Nm]	P ₁ [kW]	
10000			20000	50000	100000	500000	1000000	2000000					
1	3,48	2100	1994	1854	1807	1374	1116	906	1400	402	735	31,60	3600
	4,26	1951	1855	1822	1797	1349	1096	890		328	767	26,91	3280
	5,77	1804	1673	1602	1444	1102	1042	864		243	816	21,15	2640
	7,20	1329	1198	1044	941	739	693	669		194	670	13,92	2083
2	12,11	2100	1994	1854	1807	1374	1116	906	1400	116	1068	13,47	3600
	14,84	1951	1855	1822	1797	1349	1096	890		94	1115	11,48	3280
	18,17	1951	1855	1822	1797	1349	1096	890		77	1185	9,96	3280
	20,08	2100	1994	1854	1807	1374	1116	906		70	1243	9,46	3600
	24,60	1951	1855	1822	1797	1349	1096	890		57	1297	8,06	3280
	30,69	1951	1855	1685	1561	1308	1096	890		46	1321	6,57	3280
	33,28	1804	1673	1602	1444	1102	1042	864		42	1117	5,12	2640
	41,54	1804	1673	1602	1444	1102	1042	864		34	1137	4,18	2640
51,84	1329	1198	1044	941	739	693	669	27	811	2,39	2083		
3	51,63	1951	1855	1822	1797	1349	1096	890	1400	27	1621	4,90	3280
	63,25	1951	1855	1822	1797	1349	1096	890		22	1722	4,25	3280
	69,87	2100	1994	1854	1807	1374	1116	906		20	1741	3,89	3600
	77,48	1951	1855	1822	1797	1349	1096	890		18	1775	3,57	3280
	85,59	1951	1855	1822	1797	1349	1096	890		16	1779	3,24	3280
	104,85	1951	1855	1822	1797	1349	1096	890		13	1786	2,66	3280
	106,82	1951	1855	1822	1797	1349	1096	890		13	1787	2,61	3280
	130,86	1951	1855	1822	1797	1349	1096	890		11	1794	2,14	3280
	141,90	1951	1855	1822	1797	1349	1096	890		10	1797	1,98	3280
	144,55	2100	1994	1854	1807	1374	1116	906		10	1753	1,89	3600
	177,09	1951	1855	1822	1797	1349	1096	890		7,9	1805	1,59	3280
	180,40	2100	1994	1854	1807	1374	1116	906		7,8	1787	1,54	3600
	221,00	1951	1855	1822	1797	1349	1096	890		6,3	1813	1,28	3280
239,64	1804	1673	1602	1444	1102	1042	864	5,8	1565	1,02	2640		
299,08	1804	1673	1602	1444	1102	1042	864	4,7	1618	0,84	2640		
4	220,10	1951	1855	1822	1797	1349	1096	1096	1400	6,4	1813	1,31	3280
	243,14	2100	1994	1854	1807	1374	1116	1116		5,8	1832	1,20	3600
	269,63	1951	1855	1822	1797	1349	1096	1096		5,2	1821	1,08	3280
	303,44	2100	1994	1854	1807	1374	1116	1116		4,6	1866	0,98	3600
	364,89	1951	1855	1822	1797	1349	1096	1096		3,8	1832	0,80	3280
	403,08	2100	1994	1854	1807	1374	1116	1116		3,5	1910	0,75	3600
	447,00	1951	1855	1822	1797	1349	1096	1096		3,1	1839	0,66	3280
	493,79	1951	1855	1822	1797	1349	1096	1096		2,8	1843	0,59	3280
	557,86	1951	1855	1822	1797	1349	1096	1096		2,5	1847	0,53	3280
	627,80	2100	1994	1854	1807	1374	1116	1116		2,2	1977	0,50	3600
	818,63	1951	1855	1822	1797	1349	1096	1096		1,7	1861	0,36	3280
	942,17	1951	1855	1822	1797	1349	1096	1096		1,5	1801	0,30	3280
	1021,64	1951	1855	1822	1797	1349	1096	1096		1,4	1831	0,29	3280
	1275,01	1951	1855	1822	1797	1349	1096	1096		1,1	1915	0,24	3280
	1591,22	1951	1855	1685	1561	1308	1096	1096		0,9	1999	0,20	3280
	1725,44	1804	1673	1602	1444	1102	1042	1042		0,8	1862	0,17	2640
	2153,35	1804	1673	1602	1444	1102	1042	1042		0,7	1924	0,14	2640
2687,39	1329	1198	1044	941	739	693	693	0,5	1466	0,09	2083		

P _{TN}	P	R-L-F-FC-FU FB-FCB	M MX	FS FP
201	19.3	13.3	14.8	12.4
202	12.6	9.2	10.0	8.6
203	8.2	6.2	6.7	5.9
204	6.8	5.3	5.7	5.1

1.2 Prestazioni

1.2 Performances

1.2 Leistungen

		n ₂ X h							10000 Hours Life				T _{max} [Nm]
		T _N [Nm]							n ₁ [rpm]	n ₂ [rpm]	T _N [Nm]	P ₁ [kW]	
Stadio Stage Stufe	ir	10000	20000	50000	100000	500000	1000000	2000000					
2	10,01	1307	1280	1244	1217	1153	1116	906	1400	139,9	1009	15,90	3600
	12,26	1592	1558	1514	1481	1349	1096	890		114,2	1053	12,85	3280
	16,59	1804	1673	1602	1444	1102	1042	864		84,4	1056	10,04	2640
	17,76	1248	1248	1248	1248	1248	1096	890		78,8	1177	10,44	3280
	20,70	1329	1198	1044	941	739	693	669		67,6	706	5,38	2083
	24,04	1689	1673	1602	1444	1102	1042	864		58,2	1088	7,14	2640
	29,23	941	880	807	807	807	807	807		47,9	807	4,35	3280
	39,56	1237	1156	1092	1092	1092	1042	864		35,4	1092	4,35	2640
49,37	1329	1198	1044	941	739	693	669	28,4	805	2,57	2083		
3	34,82	2100	1994	1854	1807	1374	1116	906	1400	40	1467	6,79	3600
	42,65	1951	1855	1822	1797	1349	1096	890		33	1530	5,78	3280
	52,25	1951	1855	1822	1797	1349	1096	890		27	1626	5,01	3280
	61,82	1951	1855	1822	1797	1349	1096	890		23	1711	4,46	3280
	70,71	1951	1855	1822	1797	1349	1096	890		20	1772	4,04	3280
	75,73	1951	1855	1822	1797	1349	1096	890		18	1774	3,77	3280
	88,25	1951	1855	1685	1561	1308	1096	890		16	1484	2,71	3280
	102,48	1951	1855	1822	1797	1349	1096	890		14	1785	2,81	3280
	119,42	1804	1673	1602	1444	1102	1042	864		12	1410	1,90	2640
	127,89	1951	1855	1685	1561	1308	1096	890		11	1546	1,95	3280
	168,65	1951	1855	1822	1797	1349	1096	890		8,3	1803	1,72	3280
	210,48	1951	1855	1685	1561	1308	1096	890		6,7	1633	1,25	3280
284,84	1804	1673	1602	1444	1102	1042	864	4,9	1606	0,91	2640		
4	148,43	1951	1855	1822	1797	1349	1096	890	1400	9,4	1799	2,0	3280
	181,84	1951	1855	1822	1797	1349	1096	890		7,7	1806	1,62	3280
	215,12	1951	1855	1822	1797	1349	1096	890		6,5	1812	1,37	3280
	222,76	1951	1855	1822	1797	1349	1096	890		6,3	1814	1,33	3280
	246,07	1951	1855	1822	1797	1349	1096	890		5,7	1817	1,20	3280
	263,53	1951	1855	1822	1797	1349	1096	890		5,3	1820	1,12	3280
	301,45	1951	1855	1822	1797	1349	1096	890		4,6	1825	0,99	3280
	322,84	1951	1855	1822	1797	1349	1096	890		4,3	1827	0,92	3280
	376,21	1951	1855	1822	1797	1349	1096	890		3,7	1833	0,79	3280
	407,95	1951	1855	1822	1797	1349	1096	890		3,4	1836	0,73	3280
	445,07	1951	1855	1822	1797	1349	1096	890		3,1	1839	0,67	3280
	509,12	1951	1855	1822	1797	1349	1096	890		2,7	1844	0,59	3280
	545,24	1951	1855	1822	1797	1349	1096	890		2,6	1846	0,55	3280
	591,23	1951	1855	1822	1797	1349	1096	890		2,4	1849	0,51	3280
	635,38	1951	1855	1822	1797	1349	1096	890		2,2	1852	0,47	3280
	737,85	1951	1855	1822	1797	1349	1096	890		1,9	1857	0,41	3280
	897,30	1951	1855	1822	1797	1349	1096	890		1,6	1782	0,32	3280
	972,99	1951	1855	1822	1797	1349	1096	890		1,4	1813	0,30	3280
1214,30	1951	1855	1822	1797	1349	1096	890	1,2	1897	0,25	3280		
1515,44	1951	1855	1822	1797	1349	1096	890	0,9	1981	0,21	3280		
2050,81	1804	1673	1602	1444	1102	1042	864	0,7	1910	0,15	2640		

P _{TN}	P	R-L-F-FC-FU FB-FCB	M MX	FS FP
202	11,8	9,6	10,2	9,3
203	8,8	7,3	7,7	7,1
204	6,9	5,8	6,1	5,6

1.2 Prestazioni

1.2 Performances

1.2 Leistungen

EX		$n_2 \times h$							10000 Hours Life				T_{max} [Nm]
Stadio Stage Stufe	ir	10000	20000	50000	100000	500000	1000000	2000000	n_1 [rpm]	n_2 [rpm]	T_N [Nm]	P_1 [kW]	
1	4,26	2407	2292	2250	2219	1795	1458	1184	1400	328	1020	35,79	4080
2	14,84	2407	2292	2250	2219	1795	1458	1184	1400	94	1483	15,27	4080
	18,17	2407	2292	2250	2219	1795	1458	1184		77	1576	13,25	4080
	24,60	2407	2292	2250	2219	1795	1458	1184		57	1726	10,72	4080
	30,69	2195	1964	1685	1561	1308	1212	1123		46	1321	6,57	4080
3	51,63	2407	2292	2250	2219	1798	1461	1187	1400	27	2031	6.13	4080
	63,25	2407	2292	2250	2219	1798	1461	1187		22	2065	5.09	4080
	77,48	2407	2292	2250	2219	1798	1461	1187		18	2101	4.23	4080
	85,59	2407	2292	2250	2219	1798	1461	1187		16	2196	4.00	4080
	104,85	2407	2292	2250	2219	1798	1461	1187		13	2206	3.28	4080
	106,82	2407	2292	2250	2219	1798	1461	1187		13	2206	3.22	4080
	130,86	2407	2292	2250	2219	1798	1461	1187		11	2216	2.64	4080
	141,90	2407	2292	2250	2219	1798	1461	1187		10	2219	2.44	4080
	177,09	2407	2292	2250	2219	1798	1461	1187		7.9	2229	1.96	4080
	221,00	2195	1964	1685	1561	1308	1212	1123		6.3	1642	1.16	4080
4	220,10	2407	2292	2250	2219	1798	1461	1461	1400	6,4	2239	1,62	4080
	269,63	2407	2292	2250	2219	1798	1461	1461		5,2	2248	1,33	4080
	297,86	2407	2292	2250	2219	1798	1461	1461		4,7	2253	1,21	4080
	330,31	2407	2292	2250	2219	1798	1461	1461		4,2	2258	1,09	4080
	371,73	2407	2292	2250	2219	1798	1461	1461		3,8	2263	0,97	4080
	447,00	2407	2292	2250	2219	1798	1461	1461		3,1	2271	0,81	4080
	493,79	2407	2292	2250	2219	1798	1461	1461		2,8	2276	0,73	4080
	557,86	2407	2292	2250	2219	1798	1461	1461		2,5	2281	0,65	4080
	616,26	2407	2292	2250	2219	1798	1461	1461		2,3	2286	0,59	4080
	754,94	2407	2292	2250	2219	1798	1461	1461		1,9	2295	0,48	4080
	818,63	2407	2292	2250	2219	1798	1461	1461		1,7	2299	0,45	4080
	942,17	2407	2292	2250	2219	1798	1461	1461		1,5	2223	0,38	4080
	1021,64	2407	2292	2250	2219	1798	1461	1461		1,4	2261	0,35	4080
	1275,01	2407	2292	2250	2219	1798	1461	1461		1,1	2364	0,30	4080
	1591,22	2195	1964	1685	1561	1308	1212	1212		0,9	2240	0,22	4080

P_{TN}	P	R-L-F-FC-FU FB-FCB	M MX	FS FP
251	19.3	13.3	14.8	12.4
252	12.6	9.2	10.0	8.6
253	8.2	6.2	6.7	5.9
254	6.8	5.3	5.7	5.1

1.2 Prestazioni

1.2 Performances

1.2 Leistungen

Stadio Stage Stufe	ir	n ₂ X h							n ₁ [rpm]	10000 Hours Life				T _{max} [Nm]
		10000	20000	50000	100000	500000	1000000	2000000		n ₂ [rpm]	T _N [Nm]	P ₁ [kW]		
2	12,26	1592	1558	1514	1481	1403	1370	1184	1400	114	1363	16,64	4080	
	17,76	1248	1248	1248	1248	1248	1248	1184		79	1248	11,08	4080	
	29,23	941	880	807	807	807	807	807		48	807	4,35	4080	
3	42,65	2407	2292	2250	2219	1795	1458	1184	1400	33	1999	7,55	4080	
	52,25	2407	2292	2250	2219	1795	1458	1184		27	2033	6,27	4080	
	61,82	2407	2292	2250	2219	1795	1458	1184		23	2062	5,37	4080	
	70,71	2407	2292	2250	2219	1795	1458	1184		20	2085	4,75	4080	
	75,73	2407	2292	2250	2219	1795	1458	1184		18	2097	4,46	4080	
	88,25	2195	1964	1685	1561	1308	1212	1123		16	1484	2,71	4080	
	102,48	2407	2292	2250	2219	1795	1458	1184		14	2205	3,47	4080	
	127,89	2195	1964	1685	1561	1308	1212	1123		11	1546	1,95	4080	
	168,65	2407	2292	2250	2219	1795	1458	1184		8,3	2227	2,13	4080	
	210,48	2195	1964	1685	1561	1308	1212	1123		6,7	1663	1,27	4080	
4	148,43	2407	2292	2250	2219	1798	1461	1187	1400	9,4	2221	2,44	4080	
	181,84	2407	2292	2250	2219	1798	1461	1187		7,7	2231	2,00	4080	
	215,12	2407	2292	2250	2219	1798	1461	1187		6,5	2238	1,69	4080	
	222,76	2407	2292	2250	2219	1798	1461	1187		6,3	2240	1,64	4080	
	246,07	2407	2292	2250	2219	1798	1461	1187		5,7	2244	1,49	4080	
	263,53	2407	2292	2250	2219	1798	1461	1187		5,3	2247	1,39	4080	
	301,45	2407	2292	2250	2219	1798	1461	1187		4,6	2253	1,22	4080	
	322,84	2407	2292	2250	2219	1798	1461	1187		4,3	2257	1,14	4080	
	376,21	2407	2292	2250	2219	1798	1461	1187		3,7	2264	0,98	4080	
	407,95	2407	2292	2250	2219	1798	1461	1187		3,4	2267	0,91	4080	
	445,07	2407	2292	2250	2219	1798	1461	1187		3,1	2271	0,83	4080	
	509,12	2407	2292	2250	2219	1798	1461	1187		2,7	2277	0,73	4080	
	545,24	2407	2292	2250	2219	1798	1461	1187		2,6	2280	0,68	4080	
	591,23	2407	2292	2250	2219	1798	1461	1187		2,4	2284	0,63	4080	
	635,38	2195	1964	1685	1561	1308	1212	1123		2,2	1934	0,50	4080	
	737,85	2407	2292	2250	2219	1798	1461	1187		1,9	2294	0,51	4080	
	897,30	2407	2292	2250	2219	1798	1461	1187		1,6	2201	0,40	4080	
	972,99	2407	2292	2250	2219	1798	1461	1187		1,4	2238	0,37	4080	
	1214,30	2407	2292	2250	2219	1798	1461	1187		1,2	2341	0,31	4080	
	1515,44	2195	1964	1685	1561	1308	1212	1123		0,9	2223	0,24	4080	

B

P _{TN}	P	R-L-F-FC-FU FB-FCB	M MX	FS FP
252	11,8	9,6	10,2	9,3
253	8,8	7,3	7,7	7,1
254	6,9	5,8	6,1	5,6

1.2 Prestazioni

1.2 Performances

1.2 Leistungen

EX 	n ₂ X h								10000 Hours Life				T _{max} [Nm]	
	Stadio Stage Stufe	ir	T _N [Nm]						n ₁ [rpm]	n ₂ [rpm]	T _N [Nm]	P ₁ [kW]		
10000			20000	50000	100000	500000	1000000	2000000						
1	3,60	3103	2796	2748	2711	2317	1882	1528	1400	1400	389	1252	52,02	4240
	4,25	2794	2601	2557	2523	2283	1855	1506			329	1297	45,65	3840
	5,33	2657	2383	2339	2306	2215	1799	1461			263	1347	37,78	3920
	6,20	2205	2037	2001	1973	1596	1522	1446			226	1394	33,64	3200
	7,50	2029	1880	1741	1539	1200	1145	1091			187	1096	21,86	2600
2	12,53	3103	2796	2748	2711	1795	1458	1184	1400	1400	112	1410	17,19	4240
	14,79	2794	2601	2557	2523	2017	1638	1330			95	1665	17,19	3840
	15,35	3103	2796	2748	2711	1763	1432	1163			91	1472	14,64	4240
	18,12	2794	2601	2557	2523	1980	1608	1306			77	1737	14,64	3840
	18,56	2657	2383	2339	2306	2215	1799	1461			75	1958	16,11	3920
	20,77	2961	2669	2100	1986	1712	1391	1129			67	1565	11,51	4240
	21,58	2205	2037	2001	1973	1596	1522	1446			65	1568	11,10	3200
	22,74	2657	2383	2339	2306	2215	1799	1461			62	2081	13,98	3920
	24,52	2794	2601	2446	2314	1923	1562	1269			57	1848	11,51	3840
	26,43	2205	2037	2001	1973	1596	1522	1446			53	1590	9,19	3200
	30,77	2657	2383	2339	2306	2215	1799	1461			46	2233	11,08	3920
	35,77	2205	2037	2001	1973	1596	1522	1446			39	1622	6,93	3200
	38,40	2649	2371	2057	1906	1596	1479	1371			36	1653	6,57	3920
	44,64	2205	2037	2001	1973	1596	1522	1446			31	1646	5,63	3200
54,00	2029	1880	1741	1539	1200	1145	1091	26	1252	3,54	2600			
3	43,60	3103	2796	2748	2711	1795	1458	1184	1400	1400	32	2050	7,33	4240
	51,47	2794	2601	2557	2523	2017	1638	1330			27	2421	7,33	3840
	53,41	3103	2796	2748	2711	1795	1458	1184			26	2179	6,36	4240
	63,05	2794	2601	2557	2523	2017	1638	1330			22	2485	6,15	3840
	64,59	2657	2383	2339	2306	2215	1799	1461			22	2269	5,48	3920
	72,28	3103	2796	2748	2711	1795	1458	1184			19	2386	5,15	4240
	77,24	2794	2601	2557	2523	1980	1608	1306			18	2495	5,04	3840
	79,12	2657	2383	2339	2306	2215	1799	1461			18	2279	4,49	3920
	85,33	2794	2601	2557	2523	2017	1638	1330			16	2500	4,57	3840
	104,53	2794	2601	2557	2523	1980	1608	1306			13	2509	3,74	3840
	106,49	2794	2601	2557	2523	2017	1638	1330			13	2510	3,68	3840
	107,08	2657	2383	2339	2306	2215	1799	1461			13	2293	3,34	3920
	130,45	2794	2601	2557	2523	1980	1608	1306			11	2520	3,01	3840
	133,63	2657	2383	2339	2306	2215	1799	1461			10	2304	2,69	3920
	141,46	2794	2601	2446	2314	1923	1562	1269			10	2316	2,55	3840
	163,71	2657	2383	2339	2306	2215	1799	1461			8,6	2314	2,20	3920
	176,54	2794	2601	2446	2314	1923	1562	1269			7,9	2357	2,08	3840
	190,31	2205	2037	2001	1973	1596	1522	1446			7,4	1985	1,63	3200
	221,54	2657	2383	2339	2306	2215	1799	1461			6,3	2328	1,64	3920
	257,54	2205	2037	2001	1973	1596	1522	1446			5,4	1997	1,21	3200
276,48	2649	2371	2057	1906	1596	1479	1371	5,1	2054	1,16	3920			
321,41	2205	2037	2001	1973	1596	1522	1446	4,4	2006	0,97	3200			
4	219,42	2794	2601	2557	2523	2017	1638	1330	1400	1400	6,4	2600	1,89	3840
	224,77	2657	2383	2339	2306	2215	1799	1461			6,2	2400	1,70	3920
	268,80	2794	2601	2557	2523	2017	1638	1330			5,2	2600	1,54	3840
	275,35	2657	2383	2339	2306	2215	1799	1461			5,1	2400	1,39	3920
	296,94	2794	2601	2557	2523	2017	1638	1330			4,7	2600	1,40	3840
	329,29	2794	2601	2557	2523	2017	1638	1330			4,3	2600	1,26	3840
	363,76	2794	2601	2557	2523	2017	1638	1330			3,8	2600	1,14	3840
	416,98	3103	2796	2748	2711	1795	1458	1184			3,4	2800	1,07	4240
	453,98	2794	2601	2557	2523	2017	1638	1330			3,1	2600	0,91	3840
	492,27	2794	2601	2557	2523	2017	1638	1330			2,8	2600	0,84	3840
	556,14	2794	2601	2557	2523	2017	1638	1330			2,5	2600	0,74	3840
	614,35	2794	2601	2557	2523	2017	1638	1330			2,3	2600	0,67	3840
	766,71	2794	2601	2557	2523	2017	1638	1330			1,8	2600	0,54	3840
	795,61	3103	2796	2748	2711	1795	1458	1184			1,8	2800	0,56	4240
	939,26	2794	2601	2557	2523	2017	1638	1330			1,5	2700	0,46	3840
	1018,49	2794	2601	2557	2523	2017	1638	1330			1,4	2700	0,42	3840
	1178,68	2649	2371	2057	1906	1596	1479	1371			1,2	2600	0,35	3920
	1271,08	2794	2601	2557	2523	2017	1638	1330			1,1	2700	0,34	3840
	1595,08	2649	2371	2057	1906	1596	1479	1371			0,9	2700	0,27	3920
	1990,66	2649	2371	2057	1906	1596	1479	1371			0,7	2700	0,22	3920
	2314,14	2205	2037	2001	1973	1596	1522	1446			0,6	2300	0,16	3200
	2799,36	2029	1880	1741	1539	1200	1145	1091			0,5	2100	0,12	2600

P _{EN}	P	R-L-F-FC-FU FB-FCB	M MX	FS FP	T
301	30.0	19.6	23.2	14.4	28.6
302	20.4	14.5	16.5	11.5	19.6
303	12.8	9.3	10.5	7.6	12.3
304	10.3	7.7	8.6	6.4	9.9

1.2 Prestazioni

1.2 Performances

1.2 Leistungen

		n ₂ X h							10000 Hours Life				T _{max} [Nm]
		T _N [Nm]							n ₁ [rpm]	n ₂ [rpm]	T _N [Nm]	P ₁ [kW]	
Stadio Stage Stufe	ir	10000	20000	50000	100000	500000	1000000	2000000					
2	10,35	1351	1323	1286	1257	1192	1164	1135	1400	135,3	1151	17,54	4240
	12,22	1587	1554	1510	1476	1399	1366	1333		114,6	1359	17,54	3840
	15,33	1978	1936	1881	1839	1742	1700	1461		91,3	1706	17,54	3920
	17,83	2205	2037	2001	1973	1596	1522	1446		78,5	1548	13,69	3200
	22,22	1562	1562	1562	1562	1562	1562	1461		63,0	1562	11,08	3920
	25,83	1815	1815	1815	1815	1596	1522	1446		54,2	1587	9,69	3200
	31,25	2029	1880	1741	1539	1200	1145	1091		44,8	1209	6,10	2600
	36,57	1152	1077	1010	1010	1010	1010	1010		38,3	1010	4,35	3920
	42,51	1320	1234	1174	1174	1174	1174	1174		32,9	1174	4,35	3200
51,43	1567	1465	1420	1420	1200	1145	1091	27,2	1248	3,82	2600		
3	36,02	3103	2796	2748	2711	1795	1458	1184	1400	39	1953	8,74	4240
	42,52	2794	2601	2557	2523	2017	1638	1330		33	2286	8,66	3840
	52,09	2794	2601	2557	2523	1980	1608	1306		27	2385	7,38	3840
	61,63	2794	2601	2557	2523	2017	1638	1330		23	2484	6,49	3840
	75,49	2794	2601	2557	2523	1980	1608	1306		19	2494	5,32	3840
	86,54	2961	2669	2100	1986	1712	1391	1129		16	1911	3,56	4240
	94,74	2657	2383	2339	2306	2215	1799	1461		15	2287	3,89	3920
	102,16	2794	2601	2446	2314	1923	1562	1269		14	2257	3,56	3840
	124,24	2794	2601	2557	2523	1980	1608	1306		11	2518	3,26	3840
	155,91	2657	2383	2339	2306	2215	1799	1461		9,0	2311	2,39	3920
	168,13	2794	2601	2446	2314	1923	1562	1269		8,3	2348	2,25	3840
	186,00	2205	2037	2001	1973	1596	1522	1446		7,5	1964	1,70	3200
	210,99	2657	2383	2339	2306	2215	1799	1461		6,6	2326	1,78	3920
	263,31	2649	2371	2057	1906	1596	1479	1371		5,3	2043	1,25	3920
306,10	2205	2037	2001	1973	1596	1522	1446	4,6	2004	1,05	3200		
4	125,34	3103	2796	2748	2711	1795	1458	1184	1400	11,2	2705	3,52	4240
	147,97	2794	2601	2557	2523	2017	1638	1330		9,5	2526	2,78	3840
	181,27	2794	2601	2557	2523	2017	1638	1330		7,7	2536	2,28	3840
	222,07	2794	2601	2557	2523	1980	1608	1306		6,3	2546	1,87	3840
	245,31	2794	2601	2557	2523	2017	1638	1330		5,7	2551	1,69	3840
	306,15	2794	2601	2557	2523	2017	1638	1330		4,6	2561	1,36	3840
	321,84	2794	2601	2557	2523	1980	1608	1306		4,3	2564	1,30	3840
	355,53	2794	2601	2557	2523	2017	1638	1330		3,9	2493	1,14	3840
	406,69	2794	2601	2446	2314	1923	1562	1269		3,4	2575	1,03	3840
	432,36	2794	2601	2557	2523	2017	1638	1330		3,2	2578	0,97	3840
	507,55	2794	2601	2446	2314	1923	1562	1269		2,8	2586	0,83	3840
	543,55	2794	2601	2557	2523	1980	1608	1306		2,6	2589	0,78	3840
	585,10	2794	2601	2557	2523	2017	1638	1330		2,4	2593	0,72	3840
	716,77	2794	2601	2557	2523	1980	1608	1306		2,0	2602	0,59	3840
	734,24	2657	2383	2339	2306	2215	1799	1461		1,9	2386	0,53	3920
	894,53	2794	2601	2557	2523	1980	1608	1306		1,6	2614	0,48	3840
	969,99	2794	2601	2446	2314	1923	1562	1269		1,4	2647	0,44	3840
	1152,00	2649	2371	2057	1906	1596	1479	1371		1,2	2568	0,36	3920
	1339,20	2205	2037	2001	1973	1596	1522	1446		1,0	2191	0,27	3200
	1519,12	2657	2383	2339	2306	2215	1799	1461		0,9	2680	0,29	3920
2203,94	2205	2037	2001	1973	1596	1522	1446	0,6	2352	0,17	3200		

P _{TN}	P	R-L-F-FC-FU FB-FCB	M MX	FS FP	T
302	16,8	13,0	14,3	11,1	16,3
303	12,2	9,6	10,5	8,3	11,9
304	9,4	7,5	8,1	6,5	9,1

1.2 Prestazioni

1.2 Performances

1.2 Leistungen

EX 	n ₂ X h								10000 Hours Life				T _{max} [Nm]
	Stadio Stage Stufe	ir	10000	20000	50000	100000	500000	1000000	2000000	n ₁ [rpm]	n ₂ [rpm]	T _N [Nm]	
2	12,53	3448	3269	3145	2910	1795	1458	1184	1400	112	1410	17,19	6442
	14,79	4020	3809	3680	3268	2017	1638	1330		95	1665	17,19	7600
	18,12	3973	3920	3652	3208	1980	1608	1306		77	1737	14,64	7259
	18,56	4958	4556	4468	3831	2364	1920	1560		75	2090	17,19	7680
	21,58	4210	3877	3805	3750	2627	2133	1733		65	2429	17,19	6320
	22,74	4964	4556	4468	3761	2321	1885	1531		62	2180	14,64	7680
	26,43	4210	3877	3805	3750	2579	2095	1701		53	2534	14,64	6320
	30,77	4136	3727	3014	2852	2254	1831	1487		46	2319	11,51	7374
	35,77	4210	3877	3462	3275	2505	2034	1653		39	2696	11,51	6320
	43,27	3874	3585	3362	2974	2339	2233	1888		32	2405	8,49	5040
54,00	3527	3157	2786	2581	2162	2004	1857	26	2324	6,57	5040		
3	43,60	3448	3269	3145	2910	1795	1458	1184	1400	32	2050	7,33	6442
	51,47	4020	3809	3680	3268	2017	1638	1330		27	2421	7,33	7600
	63,05	3973	3920	3652	3208	1980	1608	1306		22	2526	6,25	7259
	64,59	4958	4556	4468	3831	2364	1920	1560		22	3038	7,33	7680
	75,08	4210	3877	3805	3750	2627	2133	1733		19	3335	6,93	6320
	77,24	3973	3920	3652	3208	1980	1608	1306		18	2684	5,42	7259
	79,12	4964	4556	4468	3761	2321	1885	1531		18	3169	6,25	7680
	85,33	4020	3809	3680	3268	2017	1638	1330		16	2817	5,15	7600
	96,93	4964	4556	4468	3761	2321	1885	1531		14	3368	5,42	7680
	104,53	3973	3920	3652	3208	1980	1608	1306		13	2939	4,39	7259
	106,49	4020	3809	3680	3268	2017	1638	1330		13	3011	4,41	7600
	107,08	4958	4556	4468	3831	2364	1920	1560		13	3535	5,15	7680
	131,17	4964	4556	4468	3761	2321	1885	1531		11	3688	4,39	7680
	133,63	4958	4556	4468	3831	2364	1920	1560		10	3778	4,41	7680
	163,71	4964	4556	4468	3761	2321	1885	1531		8,6	3942	3,76	7680
	177,51	4136	3727	3014	2852	2254	1831	1487		7,9	2906	2,55	7374
	190,31	4210	3877	3805	3750	2579	2095	1701		7,4	3774	3,09	6320
	221,54	4136	3727	3014	2852	2254	1831	1487		6,3	2958	2,08	7374
	257,54	4210	3877	3462	3275	2505	2034	1653		5,4	3439	2,08	6320
	311,54	3874	3585	3362	2974	2339	2233	1888		4,5	3422	1,71	5040
4	219,42	3973	3920	3652	3208	1980	1608	1306	1400	6,4	3571	2,59	7259
	224,77	4958	4556	4468	3831	2364	1920	1560		6,2	4415	3,13	7680
	268,80	3973	3920	3652	3208	1980	1608	1306		5,2	3639	2,16	7259
	275,35	4958	4556	4468	3831	2364	1920	1560		5,1	4466	2,58	7680
	296,94	4020	3809	3680	3268	2017	1638	1330		4,7	3692	1,98	7600
	337,32	4964	4556	4468	3761	2321	1885	1531		4,2	4486	2,12	7680
	363,76	3973	3920	3652	3208	1980	1608	1306		3,8	3870	1,70	7259
	372,63	4958	4556	4468	3831	2364	1920	1560		3,8	4495	1,92	7680
	413,23	4964	4556	4468	3761	2321	1885	1531		3,4	4505	1,74	7680
	453,98	3973	3920	3652	3208	1980	1608	1306		3,1	3887	1,36	7259
	492,27	4020	3809	3680	3268	2017	1638	1330		2,8	3706	1,20	7600
	569,69	4964	4556	4468	3761	2321	1885	1531		2,5	4536	1,27	7680
	617,75	4958	4556	4468	3831	2364	1920	1560		2,3	4544	1,17	7680
	770,95	4958	4556	4468	3831	2364	1920	1560		1,8	4566	0,94	7680
	811,31	4210	3877	3805	3750	2579	2095	1701		1,7	3889	0,76	6320
	944,45	4964	4556	4468	3761	2321	1885	1531		1,5	4925	0,83	7680
	1178,68	4964	4556	4468	3761	2321	1885	1531		1,2	4946	0,67	7680
	1278,11	4136	3727	3014	2852	2254	1831	1487		1,1	4077	0,51	7374
	1595,08	4136	3727	3014	2852	2254	1831	1487		0,9	4202	0,42	7374
	1854,28	4210	3877	3462	3275	2505	2034	1653		0,8	4395	0,38	6320
	2243,08	3874	3585	3362	2974	2339	2233	1888		0,6	3874	0,28	5040
	2799,36	3527	3157	2786	2581	2162	2004	1857		0,5	3941	0,22	5040

P _{EN}	P	R-L-F-FC-FU FB-FCB	M MX	FS FP	T
402	21.2	15.2	17.3	12.2	20.3
403	13.3	9.8	11.0	8.0	12.8
404	10.6	8.0	8.9	6.7	10.2

1.2 Prestazioni

1.2 Performances

1.2 Leistungen

		n ₂ X h								10000 Hours Life				T _{max} [Nm]
		T _N [Nm]								n ₁ [rpm]	n ₂ [rpm]	T _N [Nm]	P ₁ [kW]	
Stadio Stage Stufe	ir	10000	20000	50000	100000	500000	1000000	2000000						
3	36,02	3448	3269	3145	2910	1795	1458	1184	1400	39	1936	8,66	6442	
	42,52	4020	3809	3680	3268	2017	1638	1330		33	2286	8,66	7600	
	52,20	3448	3269	3145	2910	1795	1458	1184		27	2164	6,68	6442	
	61,63	4020	3809	3680	3268	2017	1638	1330		23	2555	6,68	7600	
	75,49	3973	3920	3652	3208	1980	1608	1306		19	2666	5,69	7259	
	88,46	4136	3727	3014	2852	2254	1831	1487		16	2749	5,01	7374	
	94,74	4964	4556	4468	3761	2321	1885	1531		15	3345	5,69	7680	
	124,24	3973	3920	3652	3208	1980	1608	1306		11	3095	4,01	7259	
	155,91	4964	4556	4468	3761	2321	1885	1531		9	3885	4,01	7680	
	181,25	4210	3877	3805	3750	2579	2095	1701		7,7	3770	3,35	6320	
	210,99	4136	3727	3014	2852	2254	1831	1487		6,6	2947	2,25	7374	
	245,27	4210	3877	3462	3275	2505	2034	1653		5,7	3426	2,25	6320	
	296,70	3874	3585	3362	2974	2339	2233	1888		4,7	3394	1,84	5040	
4	125,34	3448	3269	3145	2910	1795	1458	1184	1400	11,2	2815	3,66	6442	
	147,97	4020	3809	3680	3268	2017	1638	1330		9,5	3323	3,66	7600	
	181,27	3973	3920	3652	3208	1980	1608	1306		7,7	3467	3,12	7259	
	222,07	3973	3920	3652	3208	1980	1608	1306		6,3	3576	2,62	7259	
	245,31	4020	3809	3680	3268	2017	1638	1330		5,7	3653	2,43	7600	
	306,15	4020	3809	3680	3268	2017	1638	1330		4,6	3697	1,97	7600	
	321,84	3973	3920	3652	3208	1980	1608	1306		4,3	3698	1,87	7259	
	355,53	4020	3809	3680	3268	2017	1638	1330		3,9	3727	1,71	7600	
	432,36	3973	3920	3652	3208	1980	1608	1306		3,2	3883	1,46	7259	
	514,87	4210	3877	3805	3750	2627	2133	1733		2,7	3852	1,22	6320	
	542,57	4964	4556	4468	3761	2321	1885	1531		2,6	4531	1,36	7680	
	585,10	4020	3809	3680	3268	2017	1638	1330		2,4	3754	1,05	7600	
	716,77	3973	3920	3652	3208	1980	1608	1306		2,0	3922	0,89	7259	
	734,24	4958	4556	4468	3831	2364	1920	1560		1,9	4560	1,01	7680	
	895,67	3874	3585	3362	2974	2339	2233	1888		1,6	3635	0,66	5040	
	923,08	4136	3727	3014	2852	2254	1831	1487		1,5	3885	0,69	7374	
	1122,55	4964	4556	4468	3761	2321	1885	1531		1,2	4943	0,72	7680	
	1304,96	4210	3877	3805	3750	2579	2095	1701		1,1	4165	0,52	6320	
	1519,12	4136	3727	3014	2852	2254	1831	1487		0,9	4187	0,45	7374	
	2136,26	3874	3585	3362	2974	2339	2233	1888		0,7	4099	0,31	6320	

B

P _{tn}	P	R-L-F-FC-FU FB-FCB	M MX	FS FP	T
403	12,6	10,0	10,9	8,7	12,2
404	9,6	7,7	8,4	6,8	9,4

1.2 Prestazioni

1.2 Performances

1.2 Leistungen

EX 	n ₂ X h								10000 Hours Life				T _{max} [Nm]
	Stadio Stage Stufe	ir	T _N [Nm]						n ₁ [rpm]	n ₂ [rpm]	T _N [Nm]	P ₁ [kW]	
10000			20000	50000	100000	500000	1000000	2000000					
1	3.60	5471	5086	4995	4926	4067	3303	2683	1400	389	2198	91.33	7840
	4.25	5378	4978	4890	4823	4008	3256	2644		329	2277	80.13	7600
	5.33	5234	4556	4468	4402	3889	3159	2566		263	2365	66.32	7680
	6.20	4210	3877	3805	3750	3123	2974	2538		226	2448	59.05	6320
	7.50	3874	3585	3362	2974	2339	2233	2127		187	2137	42.62	5040
2	12.53	5471	5086	4995	4926	3287	2670	2169	1400	112	2583	31.48	7840
	14.79	5378	4978	4890	4823	3692	2999	2436		95	3049	31.48	7600
	15.35	5471	5086	4995	4926	3227	2621	2129		91	2695	26.81	7840
	18.12	5378	4978	4890	4823	3625	2944	2392		77	3181	26.81	7600
	18.56	5234	4556	4468	4402	3889	3159	2566		75	3437	28.28	7680
	20.77	5471	5086	4200	3973	3135	2546	2068		67	2866	21.07	7840
	21.58	4210	3877	3805	3750	3123	2974	2538		65	3067	21.70	6320
	22.74	5234	4556	4468	4402	3889	3159	2566		62	3653	24.54	7680
	24.52	5378	4978	4890	4629	3521	2860	2323		57	3383	21.07	7600
	26.43	4210	3877	3805	3750	3123	2974	2538		53	3110	17.97	6320
	30.77	5234	4556	4468	4402	3889	3159	2566		46	4000	19.85	7680
	35.77	4210	3877	3805	3750	3123	2974	2538		39	3175	13.56	6320
	38.40	5234	4556	4228	3721	3433	3159	2566		36	3488	13.87	7680
	44.64	4210	3877	3805	3750	3123	2974	2538		31	3223	11.03	6320
	54.00	3874	3585	3362	2974	2339	2233	2127		26	2439	6.90	5040
3	43.60	5471	5086	4995	4926	3287	2670	2169	1400	32	3754	13.43	7840
	51.47	5378	4978	4890	4823	3692	2999	2436		27	4432	13.43	7600
	53.41	5471	5086	4995	4926	3227	2621	2129		26	3917	11.44	7840
	63.05	5378	4978	4890	4823	3692	2999	2436		22	4710	11.65	7600
	64.59	5234	4556	4468	4402	3889	3159	2566		22	4327	10.45	7680
	72.28	5471	5086	4995	4926	3287	2670	2169		19	4369	9.43	7840
	77.24	5378	4978	4890	4823	3625	2944	2392		18	4765	9.62	7600
	79.12	5234	4556	4468	4402	3889	3159	2566		18	4347	8.57	7680
	85.33	5378	4978	4890	4823	3692	2999	2436		16	4775	8.73	7600
	104.53	5378	4978	4890	4823	3625	2944	2392		13	4794	7.15	7600
	106.49	5378	4978	4890	4610	3692	2999	2436		13	4474	6.55	7600
	107.08	5234	4556	4468	4402	3889	3159	2566		13	4376	6.37	7680
	130.45	5378	4978	4890	4823	3625	2944	2392		11	4816	5.76	7600
	133.63	5234	4556	4468	4402	3889	3159	2566		10	4397	5.13	7680
	141.46	5378	4978	4890	4629	3521	2860	2323		10	4633	5.11	7600
	163.71	5234	4556	4468	4402	3889	3159	2566		8.6	4416	4.21	7680
	176.54	5378	4978	4890	4629	3521	2860	2323		7.9	4716	4.17	7600
	190.31	4210	3877	3805	3750	3123	2974	2538		7.4	3774	3.09	6320
	221.54	5234	4556	4468	4402	3889	3159	2566		6.3	4445	3.13	7680
	257.54	4210	3877	3805	3750	3123	2974	2538		5.4	3798	2.30	6320
	276.48	5234	4556	4228	3721	3433	3159	2566		5.1	4220	2.38	7680
321.41	4210	3877	3805	3750	3123	2974	2538	4.4	3815	1.85	6320		
4	219.42	5378	4978	4890	4823	3692	2999	2436	1400	6.4	4900	3.56	7600
	224.77	5234	4556	4468	4402	3889	3159	2566		6.2	4400	3.12	7680
	268.80	5378	4978	4890	4823	3692	2999	2436		5.2	4900	2.90	7600
	275.35	5234	4556	4468	4402	3889	3159	2566		5.1	4400	2.55	7680
	296.94	5378	4978	4890	4823	3692	2999	2436		4.7	4900	2.63	7600
	329.29	5378	4978	4890	4823	3692	2999	2436		4.3	4900	2.37	7600
	363.76	5378	4978	4890	4823	3692	2999	2436		3.8	4900	2.15	7600
	416.98	5471	5086	4995	4926	3287	2670	2169		3.4	5000	1.91	7840
	453.98	5378	4978	4890	4823	3692	2999	2436		3.1	5000	1.75	7600
	492.27	5378	4978	4890	4823	3692	2999	2436		2.8	5000	1.62	7600
	556.14	5378	4978	4890	4823	3692	2999	2436		2.5	5000	1.43	7600
	614.35	5378	4978	4890	4823	3692	2999	2436		2.3	5000	1.30	7600
	766.71	5378	4978	4890	4823	3692	2999	2436		1.8	5000	1.04	7600
	795.61	5471	5086	4995	4926	3287	2670	2169		1.8	5100	1.02	7840
	939.26	5378	4978	4890	4823	3692	2999	2436		1.5	5000	0.85	7600
	1018.49	5378	4978	4890	4823	3692	2999	2436		1.4	5000	0.78	7600
	1178.68	5234	4556	4228	3721	3433	3159	2566		1.2	5200	0.70	7680
	1271.08	5378	4978	4890	4823	3692	2999	2436		1.1	5300	0.66	7600
	1595.08	5234	4556	4228	3721	3433	3159	2566		0.9	5300	0.53	7680
	1990.66	5234	4556	4228	3721	3433	3159	2566		0.7	5300	0.42	7680
	2314.14	4210	4978	4890	4823	3692	2999	2436		0.6	4300	0.30	6320
	2799.36	3874	3585	3362	2974	2339	2233	2127		0.5	3900	0.22	5040

P _{EN}	P	R-L-F-FC-FU FB-FCB	M MX	FS FP	T
501	31.4	21.0	24.6	15.8	29.9
502	21.6	15.7	17.7	12.7	20.8
503	13.5	10.0	11.2	8.3	13.0
504	10.8	8.2	9.1	6.9	10.4

1.2 Prestazioni

1.2 Performances

1.2 Leistungen

 Stadio Stage Stufe		n ₂ X h							10000 Hours Life				T _{max} [Nm]
		T _N [Nm]							n ₁ [rpm]	n ₂ [rpm]	T _N [Nm]	P ₁ [kW]	
ir	10000	20000	50000	100000	500000	1000000	2000000						
2	9,11	3362	3311	3244	3193	3074	3023	2683	1400	153,7	2903	50	7840
	10,75	3955	3895	3815	3755	3615	3256	2644		130,2	3008	44	7600
	13,49	4938	4556	4468	4402	3889	3159	2566		103,8	3124	36	7680
	15,68	4210	3877	3805	3750	3123	2974	2538		89,3	2998	30	6320
	22,22	4498	4304	4047	3852	3401	3159	2566		63,0	3336	24	7680
	25,83	4210	3877	3805	3750	3123	2974	2538		54,2	3105	19	6320
	31,25	3874	3585	3362	2974	2339	2233	2127		44,8	2355	12	5040
	36,74	3920	3655	3285	2912	2201	1951	1729		38,1	2307	9,9	7680
	42,71	4210	3877	3720	3298	2492	2209	1958		32,8	2682	9,9	6320
51,67	3874	3585	3362	2974	2339	2233	2127	27,1	2432	7,4	5040		
3	36,02	5471	5086	4995	4926	3287	2670	2169	1400	39	3545	15,86	7840
	42,52	5378	4978	4890	4823	3692	2999	2436		33	4185	15,86	7600
	52,09	5378	4978	4890	4823	3625	2944	2392		27	4367	13,51	7600
	61,63	5378	4978	4890	4823	3692	2999	2436		23	4678	12,23	7600
	75,49	5378	4978	4890	4823	3625	2944	2392		19	4763	10,16	7600
	86,54	5471	5086	4200	3973	3135	2546	2068		16	3823	7,12	7840
	94,74	5234	4556	4468	4402	3889	3159	2566		15	4364	7,42	7680
	102,16	5378	4978	4890	4629	3521	2860	2323		14	4514	7,12	7600
	124,24	5378	4978	4890	4823	3625	2944	2392		11	4811	6,24	7600
	155,91	5234	4556	4468	4402	3889	3159	2566		9,0	4412	4,56	7680
	168,13	5378	4978	4890	4629	3521	2860	2323		8,3	4697	4,50	7600
	186,00	4210	3877	3805	3750	3123	2974	2538		7,5	3772	3,27	6320
	210,99	5234	4556	4468	4402	3889	3159	2566		6,6	4441	3,39	7680
263,31	5234	4556	4228	3721	3433	3159	2566	5,3	4189	2,56	7680		
306,10	4210	3877	3805	3750	3123	2974	2538	4,6	3812	2,01	6320		
4	125,34	5471	5086	4995	4926	3287	2670	2169	1400	11,2	4915	6,39	7600
	147,97	5378	4978	4890	4823	3692	2999	2436		9,5	4828	5,31	7840
	181,27	5378	4978	4890	4823	3692	2999	2436		7,7	4848	4,36	7840
	222,07	5378	4978	4890	4823	3625	2944	2392		6,3	4867	3,57	7600
	245,31	5378	4978	4890	4823	3692	2999	2436		5,7	4877	3,24	7600
	306,15	5378	4978	4890	4610	3692	2999	2436		4,6	4898	2,61	7680
	321,84	5378	4978	4890	4823	3625	2944	2392		4,3	4903	2,48	7840
	355,53	5378	4978	4890	4823	3692	2999	2436		3,9	4913	2,25	7840
	406,69	5378	4978	4890	4629	3521	2860	2323		3,4	4926	1,97	7840
	432,36	5378	4978	4890	4823	3692	2999	2436		3,2	4932	1,86	6320
	507,55	5378	4978	4890	4629	3521	2860	2323		2,8	4947	1,59	7600
	543,55	5378	4978	4890	4823	3625	2944	2392		2,6	4954	1,48	7680
	585,10	5378	4978	4890	4823	3692	2999	2436		2,4	4961	1,38	7680
	716,77	5378	4978	4890	4823	3625	2944	2392		2,0	4981	1,13	7600
	734,24	5234	4556	4468	4402	3889	3159	2566		1,9	4560	1,01	7600
	894,53	5378	4978	4890	4823	3625	2944	2392		1,6	5025	0,92	7840
	969,99	5378	4978	4890	4629	3521	2860	2323		1,4	5089	0,85	7840
	1152,00	5234	4556	4228	3721	3433	3159	2566		1,2	5178	0,73	7320
	1339,20	4210	3877	3805	3750	3123	2974	2538		1,0	4182	0,51	7840
	1519,12	5234	4556	4468	4402	3889	3159	2566		0,9	5257	0,56	5040
2203,94	4210	3877	3805	3750	3123	2974	2538	0,6	4502	0,33	6320		

P _{TN}	P	R-L-F-FC-FU FB-FCB	M MX	FS FP	T
502	17,6	13,8	15,1	11,9	17,0
503	12,7	10,1	11,0	8,8	12,4
504	9,8	7,9	8,5	6,9	9,5

1.2 Prestazioni

1.2 Performances

1.2 Leistungen

EX		$n_2 \times h$							10000 Hours Life				T_{max} [Nm]
Stadio Stage Stufe	ir	10000	20000	50000	100000	500000	1000000	2000000	n_1 [rpm]	n_2 [rpm]	T_N [Nm]	P_1 [kW]	
1	3,60	6729	6261	6148	6062	5423	4405	3578	1400	389	2931	121,77	9600
	5,33	6221	5620	5510	5428	5185	4211	3421		263	3153	88,43	9440
2	15,35	6729	6261	6148	6062	4303	3495	2839	1400	91	3593	35,75	9600
	22,74	6221	5620	5510	5428	5185	4211	3421		62	4871	32,71	9440
3	53,41	6729	6261	6148	6062	4303	3495	2839	1400	26	5223	15,25	9600
	65,43	6729	6261	6148	6062	4303	3495	2839		21	5551	13,23	9600
	79,12	6221	5620	5510	5428	5185	4211	3421		18	5360	10,56	9440
	88,54	6729	6261	6148	6062	4303	3495	2839		16	6005	10,58	9600
	96,93	6221	5620	5510	5428	5185	4211	3421		14	5384	8,66	9440
	110,50	6691	6261	6148	5920	4303	3495	2839		13	5841	8,24	9600
	131,17	6221	5620	5510	5428	5185	4211	3421		11	5420	6,44	9440
	163,71	6221	5620	5510	5428	5185	4211	3421		8,6	5447	5,19	9440
4	185,86	6729	6261	6148	6062	4303	3495	2839	1400	7,5	6000	5,14	9600
	227,69	6729	6261	6148	6062	4303	3495	2839		6,1	6000	4,20	9600
	278,93	6729	6261	6148	6062	4303	3495	2839		5,0	6000	3,43	9600
	308,13	6729	6261	6148	6062	4303	3495	2839		4,5	6200	3,21	9600
	337,32	6221	5620	5510	5428	5185	4211	3421		4,2	5550	2,62	9440
	384,54	6729	6261	6148	6062	4303	3495	2839		3,6	6200	2,57	9600
	413,23	6221	5620	5510	5428	5185	4211	3421		3,4	5550	2,14	9440
	471,08	6729	6261	6148	6062	4303	3495	2839		3,0	6200	2,10	9600
	510,82	6729	6261	6148	6062	4303	3495	2839		2,7	6200	1,93	9600
	559,22	6221	5620	5510	5428	5185	4211	3421		2,5	5550	1,58	9440
	569,69	6221	5620	5510	5428	5185	4211	3421		2,5	5550	1,55	9440
	637,51	6729	6261	6148	6062	4303	3495	2839		2,2	6200	1,55	9600
	697,90	6221	5620	5510	5428	5185	4211	3421		2,0	5600	1,28	9440
	795,61	6691	6261	6148	5920	4303	3495	2839		1,8	6300	1,26	9600
	944,45	6221	5620	5510	5428	5185	4211	3421		1,5	6000	1,01	9440
	1178,68	6221	5620	5510	5428	5185	4211	3421		1,2	6000	0,81	9440

P_{tN}	P	R-L-F-FC-FU FB-FCB	M MX	FS FP	T
701	31.4	21.0	24.6	15.8	29.9
702	21.6	15.7	17.7	12.7	20.8
703	13.5	10.0	11.2	8.3	13.0
704	10.8	8.2	9.1	6.9	10.4

1.2 Prestazioni

1.2 Performances

1.2 Leistungen

		n ₂ X h							10000 Hours Life				T _{max} [Nm]
		T _N [Nm]							n ₁ [rpm]	n ₂ [rpm]	T _N [Nm]	P ₁ [kW]	
Stadio Stage Stufe	ir	10000	20000	50000	100000	500000	1000000	2000000					
2	9,11	3362	3311	3244	3193	3074	3023	2972	1400	153,7	2992	51,79	9600
	13,49	4938	4863	4763	4687	4512	4211	3421		103,8	4165	48,67	9440
	22,22	4498	4304	4047	3852	3401	3207	3013		63,0	3336	23,67	9440
	36,74	3920	3655	3285	2912	2201	1951	1729		38,1	2307	9,90	9440
3	44,12	6729	6261	6148	6062	4303	3495	2839	1400	31,7	4932	18,01	9600
	65,37	6729	6261	6148	6062	4303	3495	2839		21,4	5549	13,68	9440
	94,74	6221	5620	5510	5428	5185	4211	3421		14,8	5382	9,15	9600
	105,24	6729	6261	6148	6062	4303	3495	2839		13,3	6027	9,23	9600
	155,91	6221	5620	5510	5428	5185	4211	3421		9,0	5441	5,62	9440
4	153,55	6729	6261	6148	6062	4303	3495	2839	1400	9,1	6074	6,44	9600
	188,11	6729	6261	6148	6062	4303	3495	2839		7,4	6099	5,28	9600
	222,54	6729	6261	6148	6062	4303	3495	2839		6,3	6120	4,48	9440
	272,62	6729	6261	6148	6062	4303	3495	2839		5,1	6145	3,67	9600
	317,69	6691	6261	6148	5920	4303	3495	2839		4,4	6164	3,16	9440
	366,23	6729	6261	6148	6062	4303	3495	2839		3,8	6181	2,75	9600
	403,88	6221	5620	5510	5428	5185	4211	3421		3,5	5554	2,24	9440
	448,65	6729	6261	6148	6062	4303	3495	2839		3,1	6206	2,25	9440
	542,57	6221	5620	5510	5428	5185	4211	3421		2,6	5589	1,68	9600
	607,15	6729	6261	6148	6062	4303	3495	2839		2,3	6244	1,68	9600
	682,11	6221	5620	5510	5428	5185	4211	3421		2,1	5589	1,33	9600
	757,72	6691	6261	6148	5920	4303	3495	2839		1,8	6271	1,35	9440
	899,48	6221	5620	5510	5428	5185	4211	3421		1,6	5889	1,07	9600
	1122,55	6221	5620	5510	5428	5185	4211	3421		1,2	6055	0,88	9600

B

P _{tN}	P	R-L-F-FC-FU FB-FCB	M MX	FS FP	T
702	17,6	13,8	15,1	11,9	17,0
703	12,7	10,1	11,0	8,8	12,4
704	9,8	7,9	8,5	6,9	9,5

1.2 Prestazioni

1.2 Performances

1.2 Leistungen

EX		n ₂ X h							10000 Hours Life				T _{max} [Nm]
ge Stufe	ir	T _N [Nm]							n ₁ [rpm]	n ₂ [rpm]	T _N [Nm]	P ₁ [kW]	
		10000	20000	50000	100000	500000	1000000	2000000					
1	3,50	7836	7384	7234	7120	4949	4020	3265	1400	400	2652	113,35	12000
	4,13	7719	7193	7075	6987	4909	3987	3239		339	2763	100,21	10720
	5,17	6818	6163	6051	5966	4771	3876	3148		271	2874	83,21	10400
	6,00	6659	6010	5900	5813	4602	3790	3079		233	2940	73,29	10720
	7,25	6059	5560	4967	4392	3443	3284	3050		193	3082	63,59	8320
2	12,60	7836	7384	7234	7120	4949	4020	3265	1400	111	3895	47,20	12000
	14,88	7836	7384	7234	7120	4949	4020	3265		94	4093	42,02	12000
	17,53	7719	7193	7075	6987	4909	3987	3239		80	4265	37,15	10720
	18,60	6818	6163	6051	5966	4771	3876	3148		75	4220	34,65	10400
	22,00	7719	7193	7075	6987	4909	3987	3239		64	4566	31,69	10720
	25,58	7719	7193	6807	6509	4909	3987	3239		55	4777	28,52	10720
	27,56	6818	6163	6051	5966	4771	3876	3148		51	4749	26,32	10400
	32,03	6818	6163	6051	5966	4771	3876	3148		44	4968	23,68	10400
	37,20	6659	6010	5900	5813	4602	3790	3079		38	4691	19,25	10720
	38,75	6818	6163	6051	5966	4771	3876	3148		36	5260	20,73	10400
	45,00	6659	6010	5900	5813	4602	3790	3079		31	4750	16,12	10720
	54,38	6059	5560	4967	4392	3443	3284	3050		26	3595	10,10	8320
	51,77	7836	7384	7234	7120	4730	3842	3121		27	5688	17,14	12000
	53,72	7836	7384	7234	6701	4135	3358	2728		26	5027	14,60	12000
	63,31	7719	7193	7075	6987	4639	3768	3060		22	5925	14,60	10720
74,74	7719	7193	7075	6987	4909	3987	3239	19	6590	13,75	10720		
76,56	7719	7193	7075	6987	4909	3987	3239	18	6638	13,52	10720		
85,82	7836	7384	7234	7120	4511	3664	2976	16	6312	11,47	12000		
101,14	7719	7193	7075	6987	4909	3987	3239	14	6945	10,71	10720		
107,69	7836	7384	7234	7120	4949	4020	3265	13	7077	10,25	12000		
126,92	7719	7193	7075	6987	4909	3987	3239	11	6974	8,57	10720		
136,56	6818	6163	6051	5966	4771	3876	3148	10	5963	6,81	10400		
147,55	7719	7193	6807	6509	4909	3987	3239	9,5	6531	6,90	10720		
158,40	7719	7193	7075	6565	4909	3987	3239	8,8	6655	6,55	10720		
184,14	7719	7193	6807	6509	4909	3987	3239	7,6	6627	5,61	10720		
198,40	6818	6163	6051	5966	4771	3876	3148	7,1	6009	4,72	10400		
222,75	7236	6421	5112	4892	4382	3987	3239	6,3	5040	3,53	10468		
230,64	6818	6163	6051	5966	4771	3876	3148	6,1	6027	4,08	10400		
259,62	6659	6010	5900	5813	4602	3790	3079	5,4	5891	3,54	10720		
279,00	6818	6163	6051	5966	4771	3876	3148	5,0	6051	3,38	10400		
324,00	6659	6010	5900	5813	4602	3790	3079	4,3	5918	2,85	10720		
3	180,14	7836	7384	7234	7120	4730	3842	3121	1400	7,8	7200	6,37	12000
	220,68	7836	7384	7234	7120	4644	3772	3064		6,3	7200	5,20	12000
	260,09	7719	7193	7075	6987	4909	3987	3239		5,4	7000	4,29	10720
	270,35	7836	7384	7234	7120	4730	3842	3121		5,2	7200	4,24	12000
	318,62	7719	7193	7075	6987	4909	3987	3239		4,4	7000	3,50	10720
	351,97	7719	7193	7075	6987	4909	3987	3239		4,0	7000	3,17	10720
	386,75	7836	7384	7234	6701	4135	3358	2728		3,6	7200	2,97	12000
	455,82	7719	7193	7075	6987	4639	3768	3060		3,1	7100	2,48	10720
	495,10	7836	7384	7234	7120	4730	3842	3121		2,8	7300	2,35	12000
	538,12	7719	7193	7075	6987	4909	3987	3239		2,6	7150	2,12	10720
	551,23	7719	7193	7075	6565	4909	3987	3239		2,5	7150	2,07	10720
	640,81	7719	7193	6807	6509	4909	3987	3239		2,2	7150	1,78	10720
	728,22	7719	7193	7075	6987	4909	3987	3239		1,9	7200	1,58	10720
	785,02	7719	7193	6807	6509	4909	3987	3239		1,8	7200	1,46	10720
	802,63	6818	6163	6051	5966	4771	3876	3148		1,7	6300	1,25	10400
	917,16	6818	6163	6051	5966	4771	3876	3148		1,5	6300	1,09	10400
	949,62	7236	6421	5112	4892	4382	3987	3239		1,5	6600	1,11	10468
	1062,35	7719	7193	6807	6509	4909	3987	3239		1,3	7400	1,11	10720
	1140,48	7719	7193	7075	6565	4909	3987	3239		1,2	7600	1,06	10720
	1325,81	7719	7193	6807	6509	4909	3987	3239		1,1	7700	0,93	10720
	1428,48	6818	6163	6051	5966	4771	3876	3148		1,0	6800	0,76	10400
	1603,80	7236	6421	5112	4892	4382	3987	3239		0,9	7300	0,73	10468
	1660,61	6818	6163	6051	5966	4771	3876	3148		0,8	6900	0,66	10400
	1869,23	6659	6010	5900	5813	4602	3790	3079		0,7	6800	0,58	10720
	2008,80	6818	6163	6051	5966	4771	3876	3148		0,7	6900	0,55	10400
2332,80	6659	6010	5900	5813	4602	3790	3079	0,6	6800	0,46	10720		
2818,80	6059	5560	4967	4392	3443	3284	3050	0,5	6200	0,35	8320		

P _{TN}	P	R-L-F-FC-FU FB-FCB	M MX	FS FP	T
801	42.2	27.7	29.4	20.1	40.5
802	28.7	20.4	21.4	16.0	27.7
803	17.6	12.8	13.4	10.2	17.1
804	13.9	10.3	10.7	8.4	13.5

1.2 Prestazioni

1.2 Performances

1.2 Leistungen

		n ₂ X h							10000 Hours Life				T _{max} [Nm]
		T _N [Nm]							n ₁ [rpm]	n ₂ [rpm]	T _N [Nm]	P ₁ [kW]	
Stadio Stage Stufe	ir	10000	20000	50000	100000	500000	1000000	2000000					
2	8,85	4549	4481	4391	4323	4165	4020	3265	1400	158	3503	62,38	12000
	10,43	5342	5262	5156	5076	4889	3987	3239		134	3650	55,15	10720
	13,07	6658	6163	6051	5966	4771	3876	3148		107	3796	45,79	10400
	15,18	6659	6010	5900	5813	4602	3790	3079		92	3883	40,33	10720
	18,34	6059	5560	4967	4392	3443	3284	3050		76	3346	28,76	8320
	21,53	5910	5700	5422	5213	4726	3876	3148		65	4410	32,29	10400
	25,00	6659	6010	5900	5813	4602	3790	3079		56	4510	28,44	10720
	30,21	6059	5560	4967	4392	3443	3284	3050		46	3461	18,06	8320
	35,59	4929	4633	4242	3946	3259	2963	2668		39	3362	14,89	10400
	41,33	5650	5306	4852	4508	3711	3367	3024		34	3904	14,89	10720
49,94	6059	5560	4967	4392	3443	3284	3050	28	3576	11,29	8320		
3	36,23	7836	7384	7234	7120	4949	4020	3265	1400	39	5346	23,77	12000
	42,77	7836	7384	7234	7120	4949	4020	3265		33	5619	21,17	12000
	50,40	7719	7193	7075	6987	4909	3987	3239		28	5855	18,71	10720
	63,25	7719	7193	7075	6987	4909	3987	3239		22	6268	15,96	10720
	73,53	7719	7193	6807	6509	4909	3987	3239		19	6231	13,65	10720
	91,67	7719	7193	7075	6987	4909	3987	3239		15	6932	12,18	10720
	106,56	7719	7193	6807	6509	4909	3987	3239		13	6391	9,66	10720
	120,21	7719	7193	7075	6987	4909	3987	3239		12	6967	9,34	10720
	133,47	6818	6163	6051	5966	4771	3876	3148		10	5961	7,19	10400
	150,86	7719	7193	7075	6987	4909	3987	3239		9	6996	7,47	10720
	175,37	7719	7193	6807	6509	4909	3987	3239		8,0	6606	6,07	10720
	188,95	6818	6163	6051	5966	4771	3876	3148		7,4	6003	5,12	10400
	219,66	6818	6163	6051	5966	4771	3876	3148		6,4	6021	4,42	10400
	265,71	6818	6163	6051	5966	4771	3876	3148		5,3	6045	3,66	10400
	308,57	6659	6010	5900	5813	4602	3790	3079		4,5	5912	3,09	10720
4	148,82	7836	7384	7234	7120	4730	3842	3121	1400	9,4	7130	7,80	12000
	182,01	7719	7193	7075	6987	4639	3768	3060		7,7	7020	6,28	10720
	214,87	7719	7193	7075	6987	4909	3987	3239		6,5	7041	5,34	10720
	220,11	7719	7193	7075	6987	4909	3987	3239		6,4	7045	5,21	10720
	263,78	7719	7193	7075	6987	4639	3768	3060		5,3	7068	4,36	10720
	290,78	7719	7193	7075	6987	4909	3987	3239		4,8	7080	3,97	10720
	319,00	7719	7193	7075	6987	4909	3987	3239		4,4	7092	3,62	10720
	364,90	7719	7193	7075	6987	4909	3987	3239		3,8	7109	3,17	10720
	421,42	7719	7193	7075	6987	4909	3987	3239		3,3	7128	2,76	10720
	455,40	7719	7193	7075	6565	4909	3987	3239		3,1	7138	2,55	10720
	512,49	7719	7193	7075	6987	4909	3987	3239		2,7	7153	2,27	10720
	588,46	7836	7384	7234	7120	4511	3664	2976		2,4	7356	2,04	12000
	660,00	7719	7193	7075	6565	4909	3987	3239		2,1	7185	1,77	10468
	738,46	7836	7384	7234	7120	4949	4020	3265		1,9	7393	1,63	12000
	767,25	7719	7193	6807	6509	4909	3987	3239		1,8	7204	1,53	10720
	870,33	7719	7193	7075	6987	4909	3987	3239		1,6	7219	1,35	10720
	1011,76	7719	7193	6807	6509	4909	3987	3239		1,4	7378	1,19	10720
	1262,67	7719	7193	6807	6509	4909	3987	3239		1,1	7610	0,98	10720
	1527,43	7236	6421	5112	4892	4382	3987	3239		0,9	7339	0,78	10468
	1780,22	6659	6010	5900	5813	4602	3790	3079		0,8	6881	0,63	10720
1913,14	6818	6163	6051	5966	4771	3876	3148	0,7	7060	0,60	10400		
2221,71	6659	6010	5900	5813	4602	3790	3079	0,6	7086	0,52	10720		

P _{TN}	P	R-L-F-FC-FU FB-FCB	M MX	FS FP	T
802	23,6	18,3	18,9	15,5	23,0
803	16,9	13,3	13,7	11,4	16,5
804	12,8	10,1	10,4	8,7	12,5



1.2 Prestazioni

1.2 Performances

1.2 Leistungen

EX		n ₂ X h								10000 Hours Life				T _{max} [Nm]
ge Stufe	ir	T _N [Nm]								n ₁ [rpm]	n ₂ [rpm]	T _N [Nm]	P ₁ [kW]	
		10000	20000	50000	100000	500000	1000000	2000000						
2	12.60	9451	9326	9160	8808	5435	4414	3585	1400	111	4277	51.83	14484	
	14.88	8793	8679	8528	8413	5356	4350	3534		94	4430	45.48	13117	
	17.53	10332	9884	9716	9589	6009	4881	3964		80	5221	45.48	15460	
	18.60	9202	8446	8287	8166	6540	5312	4315		75	5785	47.50	14800	
	22.00	9455	9321	9144	9010	5830	4735	3846		64	5423	37.64	15520	
	25.58	8085	7975	6807	6509	5768	4685	3805		55	5613	33.52	12883	
	27.56	9202	8446	8287	8166	6540	5312	4315		51	6509	36.07	14800	
	32.03	9202	8446	8287	8031	6540	5312	4315		44	6810	32.46	14800	
	37.20	9207	8266	8105	7983	6290	5196	4220		38	6420	26.36	16000	
	38.75	9202	8446	8287	8166	6540	5312	4315		36	7210	28.41	13111	
	45.00	9207	8266	8105	7983	6290	5196	4220		31	6508	22.08	15226	
54.38	8369	7648	6826	5993	4622	4392	4162	26	4842	13.60	12560			
3	51.77	8793	8679	8528	7666	4730	3842	3121	1400	27	5688	17.14	13117	
	53.72	9451	9326	8250	6701	4135	3358	2728		26	5027	14.60	14484	
	63.31	10637	9884	9255	7517	4639	3768	3060		22	5925	14.60	15520	
	74.74	10332	9884	9716	8444	5210	4232	3437		19	6995	14.60	15460	
	76.56	9455	9321	9144	9010	5830	4735	3846		18	7883	16.06	15520	
	85.82	8793	8134	7559	7151	4511	3664	2976		16	6312	11.47	13117	
	101.14	10001	9461	8793	8202	5061	4111	3339		14	7439	11.47	15460	
	107.69	8049	7936	7786	7672	5196	4221	3428		13	7629	11.05	13391	
	126.92	9455	9321	9144	9010	5830	4735	3846		11	8991	11.05	15520	
	136.56	9202	8446	8287	8031	6540	5312	4315		10	8017	9.16	14800	
	147.55	8085	7975	6807	6509	5768	4685	3805		9,5	6531	6.90	12883	
	158.40	8457	7836	7085	6565	5500	4735	3846		8,8	6655	6.55	15520	
	184.14	8085	7975	6807	6509	5768	4685	3805		7,6	6627	5.61	12883	
	198.40	9202	8446	8287	8021	6540	5312	4315		7,1	8227	6.47	14800	
	222.75	7236	6421	5112	4892	4382	4162	3760		6,3	5040	3.53	10468	
	230.64	9202	8446	8287	8031	6540	5312	4315		6,1	8253	5.58	14800	
	259.62	9207	8266	7263	6943	6200	5196	4220		5,4	7228	4.34	15226	
279.00	8732	7711	6314	6038	5399	5123	4315	5,0	6312	3.53	13111			
324.00	9207	8266	7263	6943	6200	5196	4220	4,3	7330	3.53	15226			
4	180.14	8793	8679	8528	7666	4730	3842	3121	1400	7,8	8200	7.25	13117	
	220.68	8793	8679	8528	7666	4730	3842	3121		6,3	8200	5.92	13117	
	260.09	10332	9884	9716	8444	5210	4232	3437		5,4	9700	5.94	15460	
	270.35	8793	8679	8528	7666	4730	3842	3121		5,2	8500	5.01	13117	
	318.62	10332	9884	9716	8444	5210	4232	3437		4,4	9800	4.90	15460	
	351.97	10332	9884	9716	8444	5210	4232	3437		4,0	9800	4.44	15460	
	386.75	9451	9326	8250	6701	4135	3358	2728		3,6	8400	3.46	14484	
	455.82	10637	9884	9255	7517	4639	3768	3060		3,1	9400	3.29	15520	
	495.10	8793	8679	8528	7666	4730	3842	3121		2,8	8600	2.77	13117	
	538.12	10332	9884	9716	8444	5210	4232	3437		2,6	9800	2.90	15460	
	551.23	8457	7836	7085	6565	5500	4735	3846		2,5	7800	2.25	15520	
	640.81	8085	7975	6807	6509	5768	4685	3805		2,2	7800	1.94	12883	
	728.22	10332	9884	9716	8444	5210	4232	3437		1,9	9800	2.14	15460	
	785.02	8085	7975	6807	6509	5768	4685	3805		1,8	8100	1.64	12883	
	802.63	9202	8446	8287	8031	6540	5312	4315		1,7	8600	1.71	14800	
	917.16	9202	8446	8287	8166	6540	5312	4315		1,5	8600	1.49	14800	
	949.62	7236	6421	5112	4892	4382	4162	3760		1,5	6800	1.14	10468	
	1062.35	8085	7975	6807	6509	5768	4685	3805		1,3	8000	1.20	12883	
	1140.48	8457	7836	7085	6565	5500	4735	3846		1,2	8000	1.12	15520	
	1325.81	8085	7975	6807	6509	5768	4685	3805		1,1	8100	0.97	12883	
	1428.48	9202	9202	9202	9202	9202	9202	9202		1,0	9200	1.03	14800	
	1603.80	7236	6421	5112	4892	4382	4162	3760		0,9	7400	0.74	10468	
	1660.61	9202	8446	8287	8031	6540	5312	4315		0,8	9600	0.92	14800	
	1869.23	9207	8266	7263	6943	6200	5196	4220		0,7	9600	0.82	15226	
	2008.80	8732	7711	6314	6038	5399	5123	4315		0,7	9200	0.73	13111	
	2332.80	9207	8266	7263	6943	6200	5196	4220		0,6	9600	0.66	15226	
	2818.80	8369	7648	6826	5993	4622	4392	4162		0,5	8600	0.49	12560	

P _{TN}	P	R-L-F-FC-FU FB-FCB	FS FP	T
902	30.4	25.6	16.9	28.6
903	18.6	15.8	10.8	17.6
904	14.6	12.6	8.7	13.9

1.2 Prestazioni

1.2 Performances

1.2 Leistungen

 Stadio Stage Stufe		n ₂ X h							10000 Hours Life				T _{max} [Nm]
		T _N [Nm]							n ₁ [rpm]	n ₂ [rpm]	T _N [Nm]	P ₁ [kW]	
ir	10000	20000	50000	100000	500000	1000000	2000000						
3	36,23	9451	9326	9160	8808	5435	4414	3585	1400	39	5871	26,11	14484
	42,77	8793	8679	8528	8413	5356	4350	3534		33	6082	22,91	13117
	50,40	10332	9884	9716	9589	6009	4881	3964		28	7168	22,91	15460
	63,25	9455	9321	9144	9010	5830	4735	3846		22	7444	18,96	15520
	73,05	10332	9884	9716	9589	6009	4881	3964		19	8012	17,67	15460
	92,10	9202	8446	8287	8031	6540	5312	4315		15	7805	13,65	14800
	106,95	9207	8266	8105	7983	6290	5196	4220		13	7650	11,52	16000
	127,54	9202	8446	8287	8166	6540	5312	4315		11	8150	10,29	14800
	133,47	9202	8446	8287	8031	6540	5312	4315		10	8005	9,66	14800
	155,00	9207	8266	8105	7983	6290	5196	4220		9	8001	8,32	16000
	161,46	9202	8446	8287	8166	6540	5312	4315		8,7	6095	6,08	13111
	188,95	9202	8446	8287	8166	6540	5312	4315		7,4	8218	7,01	14800
	219,66	9202	8446	8287	8031	6540	5312	4315		6,4	8245	6,05	14800
	265,71	9202	8446	8287	8166	6540	5312	4315		5,3	6293	3,82	13111
308,57	9207	8266	8105	7983	6290	5196	4220	4,5	7308	3,82	15226		
4	148,82	8793	8679	8528	7666	4730	3842	3121	1400	9,4	7808	8,55	13117
	182,01	10637	9884	9255	7517	4639	3768	3060		7,7	8133	7,28	15520
	214,87	10332	9884	9716	8444	5210	4232	3437		6,5	9602	7,28	15460
	220,11	9455	9321	9144	9010	5830	4735	3846		6,4	9068	6,71	15520
	263,78	10637	9884	9255	7517	4639	3768	3060		5,3	9091	5,61	15520
	290,78	10001	9461	8793	8202	5061	4111	3339		4,8	8819	4,94	15460
	319,00	9455	9321	9144	9010	5830	4735	3846		4,4	9169	4,68	15520
	364,90	9455	9321	9144	9010	5830	4735	3846		3,8	9195	4,10	15520
	421,42	10001	9461	8793	8202	5061	4111	3339		3,3	9095	3,52	15460
	455,40	8457	7836	7085	6565	5500	4735	3846		3,1	7474	2,67	15520
	512,49	10332	9884	9716	8444	5210	4232	3437		2,7	9827	3,12	15460
	588,46	8793	8134	7559	7151	4511	3664	2976		2,4	8022	2,22	13117
	663,09	9202	8446	8287	8031	6540	5312	4315		2,1	8437	2,07	14800
	746,39	9207	8266	7263	6943	6200	5196	4220		1,9	8277	1,81	15226
	870,33	9455	9321	9144	9010	5830	4735	3846		1,6	9363	1,75	15520
	961,00	9202	8446	8287	8031	6540	5312	4315		1,5	8672	1,47	14800
	1162,50	8732	7711	6314	6038	5399	5123	4315		1,2	8458	1,19	13111
	1581,53	9202	8446	8287	8031	6540	5312	4315		0,9	9374	0,97	14800
	1780,22	9207	8266	7263	6943	6200	5196	4220		0,8	9554	0,87	15226
	1913,14	8732	7711	6314	6038	5399	5123	4315		0,7	9192	0,78	13111
2221,71	9207	8266	7263	6943	6200	5196	4220	0,6	9873	0,72	15226		

B

P _{TN}	P	R-L-F-FC-FU FB-FCB	FS FP	T
903	17,6	15,6	11,7	16,9
904	13,3	11,8	9,0	12,8



1.2 Prestazioni

1.2 Performances

1.2 Leistungen

EX		n ₂ X h								10000 Hours Life				T _{max} [Nm]
ge Stufe	ir	T _N [Nm]								n ₁ [rpm]	n ₂ [rpm]	T _N [Nm]	P ₁ [kW]	
		10000	20000	50000	100000	500000	1000000	2000000						
1	3.50	11827	11118	10882	10704	6784	5510	4476	1400	1400	400	3635	155,37	17600
	4.13	11700	10872	10688	10548	6729	5465	4439			339	3788	137,37	15520
	5.17	10122	9291	9116	8983	6540	5312	4315			271	3939	114,05	14800
	6.00	9207	8266	8105	7983	6290	5196	4220			233	4029	100,46	16000
	7.25	8369	7648	6826	5993	4622	4392	4162			193	4173	86,11	12560
2	12.60	11827	11118	10882	10704	6784	5510	4476	1400	1400	111	5339	64,70	17600
	14.88	11827	11118	10882	10704	6784	5510	4476			94	5611	57,60	17600
	17.53	11700	10872	10688	10548	6729	5465	4439			80	5847	50,93	15520
	18.60	10122	9291	9116	8983	6540	5312	4315			75	5785	47,50	14800
	22.00	11700	10872	10688	10548	6729	5465	4439			64	6259	43,44	15520
	25.58	11700	10872	10688	10548	6729	5465	4439			55	6548	39,10	15520
	27.56	10122	9291	9116	8983	6540	5312	4315			51	6509	36,07	14800
	32.03	10122	9291	9116	8983	6540	5312	4315			44	6810	32,46	14800
	37.20	9207	8266	8105	7983	6290	5196	4220			38	6420	26,36	16000
	38.75	10122	9291	9116	8983	6540	5312	4315			36	7210	28,41	14800
	45.00	9207	8266	8105	7983	6290	5196	4220			31	6508	22,08	16000
	54.38	8369	7648	6826	5993	4622	4392	4162			26	4842	13,60	12560
	3	51.77	11827	11118	10882	10704	6784	5510			4476	1400	1400	27
53.72		11827	11118	10882	10704	6784	5510	4476	26	8248	23,95			17600
63.31		11700	10872	10688	10548	6729	5465	4439	22	8594	21,17			15520
74.74		11700	10872	10688	10548	6729	5465	4439	19	9033	18,85			15520
76.56		11700	10872	10688	10548	6729	5465	4439	18	9099	18,53			15520
85.82		11827	11118	10882	10704	6784	5510	4476	16	9493	17,25			17600
101.14		11700	10872	10688	10548	6729	5465	4439	14	9530	14,69			15520
107.69		11827	11118	10882	10704	6784	5510	4476	13	9669	14,00			17600
126.92		11700	10872	10688	10548	6729	5465	4439	11	9571	11,76			15520
136.56		10122	9291	9116	8983	6540	5312	4315	10	8162	9,32			14800
147.55		11700	10872	10688	10548	6729	5465	4439	9	9599	10,15			15520
158.40		11700	10872	10688	10548	6729	5465	4439	9	9612	9,46			15520
184.14		11700	10872	10688	10548	6729	5465	4439	7,6	9639	8,16			15520
198.40		10122	9291	9116	8983	6540	5312	4315	7,1	8227	6,47			14800
222.75		11700	10872	9961	9534	6729	5465	4439	6,3	9674	6,77			15520
230.64		10122	9291	9116	8983	6540	5312	4315	6,1	8253	5,58			14800
259.62		9207	8266	8105	7983	6290	5196	4220	5,4	8091	4,86			16000
279.00		10122	9291	9116	8983	6540	5312	4315	5,0	8286	4,63			14800
324.00		9207	8266	8105	7983	6290	5196	4220	4,3	8130	3,91			16000
4	180.14	11827	11118	10882	10704	6784	5510	4476	1400	1400	7,8	9700	8,58	17600
	220.68	11827	11118	10882	10704	6784	5510	4476			6,3	9700	7,00	17600
	260.09	11700	10872	10688	10548	6729	5465	4439			5,4	9700	5,94	15520
	270.35	11827	11118	10882	10704	6784	5510	4476			5,2	9800	5,78	17600
	318.62	11700	10872	10688	10548	6729	5465	4439			4,4	9800	4,90	15520
	351.97	11700	10872	10688	10548	6729	5465	4439			4,0	9800	4,44	15520
	386.75	11827	11118	10882	10704	6784	5510	4476			3,6	9950	4,10	17600
	455.82	11700	10872	10688	10548	6729	5465	4439			3,1	9850	3,44	15520
	495.10	11827	11118	10882	10704	6784	5510	4476			2,8	9900	3,19	17600
	538.12	11700	10872	10688	10548	6729	5465	4439			2,6	9800	2,90	15520
	551.23	11700	10872	10688	10548	6729	5465	4439			2,5	9800	2,83	15520
	640.81	11700	10872	10688	10548	6729	5465	4439			2,2	9800	2,44	15520
	728.22	11700	10872	10688	10548	6729	5465	4439			1,9	9900	2,17	15520
	785.02	11700	10872	10688	10548	6729	5465	4439			1,8	9900	2,01	15520
	802.63	10122	9291	9116	8983	6540	5312	4315			1,7	8700	1,73	14800
	917.16	10122	9291	9116	8983	6540	5312	4315			1,5	8700	1,51	14800
	949.62	11700	10872	9961	9534	6729	5465	4439			1,5	10000	1,68	15520
	1062.35	11700	10872	10688	10548	6729	5465	4439			1,3	10000	1,50	15520
	1140.48	11700	10872	10688	10548	6729	5465	4439			1,2	10500	1,47	15520
	1325.81	11700	10872	10688	10548	6729	5465	4439			1,1	10500	1,26	15520
	1428.48	10122	9291	9116	8983	6540	5312	4315			1,0	9200	1,03	14800
	1603.80	11700	10872	9961	9534	6729	5465	4439			0,9	10700	1,06	15520
	1660.61	10122	9291	9116	8983	6540	5312	4315			0,8	9600	0,92	14800
	1869.23	9207	8266	8105	7983	6290	5196	4220			0,7	9600	0,82	16000
	2008.80	10122	9291	9116	8983	6540	5312	4315			0,7	9600	0,76	14800
	2332.80	9207	8266	8105	7983	6290	5196	4220			0,6	9600	0,66	16000
	2818.80	8369	7648	6826	5993	4622	4392	4162			0,5	8600	0,49	12560

P _{TN}	P	R-L-F-FC-FU FB-FCB	FS FP	T
1001	45.2	36.9	21.6	42.1
1002	31.1	26.4	17.7	29.4
1003	20.3	17.5	12.5	19.3
1004	15.9	13.8	10.0	15.1

1.2 Prestazioni

1.2 Performances

1.2 Leistungen

		n ₂ X h							10000 Hours Life				T _{max} [Nm]
		T _N [Nm]							n ₁ [rpm]	n ₂ [rpm]	T _N [Nm]	P ₁ [kW]	
Stadio Stage Stufe	ir	10000	20000	50000	100000	500000	1000000	2000000					
2	8,85	4549	4481	4391	4323	4165	4097	4029	1400	158	4052	72,14	17600
	10,43	5342	5262	5156	5076	4889	4809	4439		134	4775	72,14	15520
	13,07	6658	6558	6425	6325	6092	5312	4315		107	5204	62,77	14800
	15,18	7707	7590	7436	7320	6290	5196	4220		92	5323	55,29	16000
	18,34	8369	7648	6826	5993	4622	4392	4162		76	4481	38,52	12560
	21,53	5910	5700	5422	5213	4726	4516	4306		65	4646	34,02	14800
	25,00	6810	6567	6245	6001	5435	5192	4220		56	5396	34,02	16000
	30,21	8149	7648	6826	5993	4622	4392	4162		46	4647	24,25	12560
	35,59	4929	4633	4242	3946	3259	2963	2668		39	3362	14,89	14800
	41,33	5650	5306	4852	4508	3711	3367	3024		34	3904	14,89	16000
49,94	6713	6298	5750	5334	4370	3955	3540	28	4717	14,89	12560		
3	31,87	11827	11118	10882	10704	6784	5510	4476	1400	44	7062	35,70	17600
	44,34	11700	10872	10688	10548	6729	5465	4439		32	7724	28,06	15520
	55,65	11700	10872	10688	10548	6729	5465	4439		25	8268	23,94	15520
	64,69	11700	10872	10688	10548	6729	5465	4439		22	8650	21,54	15520
	73,05	11700	10872	10688	10548	6729	5465	4439		19	8971	19,78	15520
	91,67	11700	10872	10688	10548	6729	5465	4439		15	9512	16,72	15520
	106,56	11700	10872	10688	10548	6729	5465	4439		13	9539	14,42	15520
	120,77	11700	10872	10688	10548	6729	5465	4439		12	9562	12,75	15520
	133,47	10122	9291	9116	8983	6540	5312	4315		10	8158	9,85	14800
	151,56	11700	10872	10688	10548	6729	5465	4439		9	9604	10,21	15520
	176,18	11700	10872	10688	10548	6729	5465	4439		7,9	9631	8,81	15520
	189,83	10122	9291	9116	8983	6540	5312	4315		7,4	8219	6,97	14800
	220,67	10122	9291	9116	8983	6540	5312	4315		6,3	8245	6,02	14800
	266,94	10122	9291	9116	8983	6540	5312	4315		5,2	8279	5,00	14800
310,00	9207	8266	8105	7983	6290	5196	4220	4,5	8123	4,22	16000		
4	148,82	11827	11118	10882	10704	6784	5510	4476	1400	9,4	9745	10,67	17600
	182,01	11700	10872	10688	10548	6729	5465	4439		7,7	9637	8,62	15520
	214,87	11700	10872	10688	10548	6729	5465	4439		6,5	9668	7,33	15520
	220,11	11700	10872	10688	10548	6729	5465	4439		6,4	9672	7,16	15520
	263,78	11700	10872	10688	10548	6729	5465	4439		5,3	9705	5,99	15520
	290,78	11700	10872	10688	10548	6729	5465	4439		4,8	9723	5,45	15520
	319,00	11700	10872	10688	10548	6729	5465	4439		4,4	9740	4,97	15520
	364,90	11700	10872	10688	10548	6729	5465	4439		3,8	9764	4,36	15520
	421,42	11700	10872	10688	10548	6729	5465	4439		3,3	9791	3,78	15520
	455,40	11700	10872	10688	10548	6729	5465	4439		3,1	9805	3,51	15520
	512,49	11700	10872	10688	10548	6729	5465	4439		2,7	9827	3,12	15520
	588,46	11827	11118	10882	10704	6784	5510	4476		2,4	10067	2,79	17600
	660,00	11700	10872	10688	10548	6729	5465	4439		2,1	9873	2,44	15520
	738,46	11827	11118	10882	10704	6784	5510	4476		1,9	10120	2,23	17600
	767,25	11700	10872	10688	10548	6729	5465	4439		1,8	9900	2,10	15520
	870,33	11700	10872	10688	10548	6729	5465	4439		1,6	9926	1,86	15520
	1011,76	11700	10872	10688	10548	6729	5465	4439		1,4	10151	1,63	15520
	1262,67	11700	10872	10688	10548	6729	5465	4439		1,1	10482	1,35	15520
	1527,43	11700	10872	9961	9534	6729	5465	4439		0,9	10767	1,15	15520
	1780,22	9207	8266	8105	7983	6290	5196	4220		0,8	9554	0,87	16000
	1913,14	10122	9291	9116	8983	6540	5312	4315		0,7	9642	0,82	14800
	2221,71	9207	8266	8105	7983	6290	5196	4220		0,6	9873	0,72	16000

P _{tn}	P	R-L-F-FC-FU FB-FCB	FS FP	T
1002	25,2	22,1	16,6	24,1
1003	18,9	16,8	13,0	18,1
1004	14,2	12,7	10,0	13,7



1.2 Prestazioni

1.2 Performances

1.2 Leistungen

EX 	n ₂ X h								10000 Hours Life				T _{max} [Nm]
	Stadio Stage Stufe	ir	T _N [Nm]						n ₁ [rpm]	n ₂ [rpm]	T _N [Nm]	P ₁ [kW]	
10000			20000	50000	100000	500000	1000000	2000000					
1	3.72	16904	15971	15664	15431	11227	9119	7407	1400	376	6128	246.40	28800
	4.09	18257	17249	16917	16665	11182	9083	7377		342	6279	229.61	30240
	5.25	18420	17081	16797	16583	10913	8864	7200		267	6605	188.19	24800
	6.23	17333	15583	13699	11959	9630	8651	7027		225	6786	162.92	26400
2	13.39	16904	15971	15664	15431	9956	8087	6569	1400	105	7980	90.99	28465
	14.73	18257	17249	16917	16665	10641	8643	7021		95	8776	90.99	30240
	17.39	18257	17249	16917	16665	10487	8518	6919		81	9090	79.84	30240
	18.90	18420	17081	16797	16583	10913	8864	7200		74	9699	78.37	24800
	22.31	18420	17081	16797	16583	10913	8864	7200		63	10195	69.77	24800
	25.36	15254	15036	13236	12641	10067	8177	6642		55	9773	58.84	25234
	28.00	18420	17081	16797	16583	10913	8864	7200		50	10913	59.52	24800
	32.55	18420	17081	16711	15947	10913	8864	7200		43	11417	53.56	24800
	33.23	17333	15583	13699	11959	9630	8651	7027		42	9743	44.77	26400
	39.38	17087	15101	12488	11945	10683	8864	7200		36	10950	42.47	24800
	46.73	17333	15583	13699	11959	9630	8651	7027		30	9967	32.57	26400
	51.25	18257	17249	16917	13940	8601	6986	5675		27	10312	31.38	30240
3	60.50	18257	17249	16917	15657	9661	7847	6374	1400	23	12173	31.38	30240
	62.78	18257	17249	16848	13685	8444	6859	5571		22	10759	26.72	30240
	74.12	18257	17249	16917	15371	9485	7704	6257		19	12701	26.72	30240
	77.65	18420	17081	16797	16583	10913	8864	7200		18	14820	29.77	24800
	80.57	18420	17081	16797	16296	10055	8167	6634		17	13807	26.72	24800
	95.12	18420	17081	16797	16583	10913	8864	7200		15	15750	25.82	24800
	100.31	18257	17249	16917	14931	9213	7483	6078		14	13509	21.00	30240
	109.04	18420	17081	16797	15829	9767	7933	6444		13	14685	21.00	24800
	119.37	18420	17081	16797	16583	10913	8864	7200		12	16533	21.60	24800
	128.73	18420	17081	16797	16583	10913	8864	7200		11	16557	20.06	24800
	138.77	18420	17081	16711	15947	10913	8864	7200		10	15937	17.91	24800
	146.33	15254	15036	13236	12641	10067	8177	6642		10	12678	13.51	30240
	157.09	17395	15677	14333	13845	10175	8264	6713		8.9	13925	13.82	30240
	161.54	18420	17081	16797	16583	10913	8864	7200		8.7	16627	16.05	24800
	187.79	18420	17081	16711	15947	10913	8864	7200		7.5	16271	13.51	24800
	201.60	18420	17081	16797	16583	10913	8864	7200		6.9	16695	12.92	24800
	234.36	18420	17081	16711	15947	10913	8864	7200		6.0	16515	10.99	24800
	239.26	17333	15583	13699	11959	9630	8651	7027		5.9	13305	8.67	26400
	278.14	17333	15583	13699	11959	9630	8651	7027		5.0	13683	7.67	26400
	283.50	17087	15101	12488	11945	10683	8864	7200		4.9	12498	6.88	24800
	336.46	17333	15583	13699	11959	9630	8651	7027		4.2	14161	6.56	26400
	210.56	18257	17249	16917	15657	9661	7847	6374		6.6	16813	12.72	30240
	218.49	18257	17249	16848	13685	8444	6859	5571		6.4	15640	11.41	30240
	257.94	18257	17249	16917	15657	9661	7847	6374		5.4	16887	10.43	30240
	270.21	18420	17081	16797	16583	10913	8864	7200		5.2	16786	9.90	24800
	280.40	18420	17081	16797	16296	10055	8167	6634		5.0	16798	9.55	24800
	315.99	18257	17249	16917	15371	9485	7704	6257		4.4	16961	8.55	30240
	331.02	18420	17081	16797	16583	10913	8864	7200		4.2	16849	8.11	24800
	343.50	18420	17081	16797	16296	10055	8167	6634		4.1	16860	7.82	24800
	405.52	18420	17081	16797	16583	10913	8864	7200		3.5	16912	6.65	24800
	415.40	18420	17081	16797	16583	10913	8864	7200		3.4	16919	6.49	24800
	447.97	18420	17081	16797	16583	10913	8864	7200		3.1	16942	6.03	24800
464.85	18420	17081	16797	16296	10055	8167	6634	3.0	16954	5.81	24800		
508.89	18420	17081	16797	16583	10913	8864	7200	2.8	16982	5.32	24800		
562.15	18420	17081	16797	16583	10913	8864	7200	2.5	17013	4.82	24800		
580.13	18420	17081	16797	16296	10055	8167	6634	2.4	17022	4.68	24800		
629.07	18420	17081	16797	15829	9767	7933	6444	2.2	17048	4.32	24800		
688.66	18420	17081	16797	16583	10913	8864	7200	2.0	17076	3.95	24800		
742.65	18420	17081	16797	16583	10913	8864	7200	1.9	17100	3.67	24800		
800.57	18420	17081	16711	15947	10913	8864	7200	1.7	17122	3.41	24800		
859.45	18420	17081	16797	16583	10913	8864	7200	1.6	17251	3.20	24800		
926.83	18420	17081	16797	16583	10913	8864	7200	1.5	17432	3.00	24800		
999.11	18420	17081	16711	15947	10913	8864	7200	1.4	17612	2.81	24800		
1163.08	18420	17081	16797	16583	10913	8864	7200	1.2	18000	2.47	24800		
1285.79	17333	15583	13699	11959	9630	8651	7027	1.1	17200	2.13	26400		
1352.08	18420	17081	16711	15947	10913	8864	7200	1.0	18336	2.16	24800		
1451.52	18420	17081	16797	16583	10913	8864	7200	1.0	18500	2.03	24800		
1687.39	18420	17081	16711	15947	10913	8864	7200	0.8	18867	1.78	24800		
2041.20	17087	15101	12488	11945	10683	8864	7200	0.7	18200	1.42	24800		
2422.52	17333	15583	13699	11959	9630	8651	7027	0.6	18200	1.20	26400		

P _{TN}	P	PH	PX	R-L-F-FC-FU FB-FCB	FS FP	H HU	X	T
1501	64.9	54.7	63.5	39.6	26.7	32.7	41.5	58.1
1502	44.4	38.6	43.6	29.9	22.6	26.0	31.0	40.5
1503	28.0	22.5	27.6	19.6	15.3	17.3	20.2	25.8
1504	21.7	19.2	21.4	15.4	12.1	13.6	15.8	20.0

1.2 Prestazioni

1.2 Performances

1.2 Leistungen

 Stadio Stage Stufe		n ₂ X h							10000 Hours Life				T _{max} [Nm]
		T _N [Nm]							n ₁ [rpm]	n ₂ [rpm]	T _N [Nm]	P ₁ [kW]	
ir	10000	20000	50000	100000	500000	1000000	2000000						
3	33,87	16904	15971	15664	15431	9956	8087	6569	1400	41	10542	50,14	28465
	37,25	18257	17249	16917	16665	10641	8643	7021		38	11593	50,13	30240
	47,81	18420	17081	16797	16583	10913	8864	7200		29	12813	43,18	24800
	56,44	18420	17081	16797	16583	10913	8864	7200		25	13467	38,44	24800
	61,36	18257	17249	16917	16665	10641	8643	7021		23	13465	35,35	30240
	64,16	15254	15036	13236	12641	10067	8177	6642		22	11971	30,06	25234
	70,82	18420	17081	16797	16583	10913	8864	7200		20	14416	32,79	24800
	78,75	18420	17081	16797	16583	10913	8864	7200		18	14883	30,45	24800
	82,33	18420	17081	16711	15947	10913	8864	7200		17	15083	29,51	24800
	92,97	18420	17081	16797	16583	10913	8864	7200		15	15643	27,11	24800
	99,60	17087	15101	12488	11945	10683	8864	7200		14	11678	18,89	24800
	116,67	18420	17081	16797	16583	10913	8864	7200		12	16526	22,82	24800
	135,63	18420	17081	16711	15947	10913	8864	7200		10	15912	18,90	24800
	153,71	18420	17081	16797	16583	10913	8864	7200		9,1	16612	17,41	24800
	174,73	15254	15036	13236	12641	10067	8177	6642		8,0	12831	11,83	25234
	192,89	18420	17081	16797	16583	10913	8864	7200		7,3	16682	13,93	24800
	224,23	18420	17081	16711	15947	10913	8864	7200		6,2	16466	11,83	24800
	271,25	17087	15101	12488	11945	10683	8864	7200		5,2	12463	7,40	24800
	321,92	17333	15583	13699	11959	9630	8651	7027		4,3	14050	7,03	26400
	4	147,35	18257	17249	16917	13940	8601	6986		5675	9,5	14155	15,65
173,95		18257	17249	16917	15657	9661	7847	6374	8,0	16711	15,65	30240	
223,24		18420	17081	16797	16583	10913	8864	7200	6,3	16727	12,20	24800	
273,47		18420	17081	16797	16583	10913	8864	7200	5,1	16790	10,00	24800	
313,49		18420	17081	16797	15829	9767	7933	6444	4,5	16832	8,75	24800	
343,18		18420	17081	16797	16583	10913	8864	7200	4,1	16860	8,00	24800	
370,09		18420	17081	16797	16583	10913	8864	7200	3,8	16883	7,43	24800	
398,95		18420	17081	16711	15947	10913	8864	7200	3,5	16907	6,90	24800	
454,33		18420	17081	16797	15829	9767	7933	6444	3,1	16947	6,08	24800	
464,42		18420	17081	16797	16583	10913	8864	7200	3,0	16954	5,95	24800	
497,37		18420	17081	16797	16583	10913	8864	7200	2,8	16975	5,56	24800	
536,36		18420	17081	16797	16583	10913	8864	7200	2,6	16998	5,16	24800	
579,60		18420	17081	16797	16583	10913	8864	7200	2,4	17022	4,78	24800	
673,08		18420	17081	16797	16583	10913	8864	7200	2,1	17068	4,13	24800	
782,45		18420	17081	16711	15947	10913	8864	7200	1,8	17115	3,56	24800	
840,00		18420	17081	16797	16583	10913	8864	7200	1,7	17137	3,32	24800	
976,50		18420	17081	16711	15947	10913	8864	7200	1,4	17557	2,93	24800	
1107,69		18420	17081	16797	16583	10913	8864	7200	1,3	17859	2,63	24800	
1382,40		18420	17081	16797	16583	10913	8864	7200	1,0	18390	2,17	24800	
1607,04		18420	17081	16711	15947	10913	8864	7200	0,9	18750	1,90	24800	
1907,26	17333	15583	13699	11959	9630	8651	7027	0,7	17818	1,52	26400		
2307,16	17333	15583	13699	11959	9630	8651	7027	0,6	18116	1,28	26400		

B

P _{TN}	P	PH	PX	R-L-F-FC-FU FB-FCB	FS FP	H HU	X	T
1503	26,8	22,7	26,5	20,5	17,2	18,7	20,9	25,1
1504	20,0	18,1	19,7	15,4	13,0	14,1	15,7	18,7



1.2 Prestazioni

1.2 Performances

1.2 Leistungen

EX 	n ₂ X h								10000 Hours Life				T _{max} [Nm]
	Stadio Stage Stufe	ir	T _N [Nm]						n ₁ [rpm]	n ₂ [rpm]	T _N [Nm]	P ₁ [kW]	
10000			20000	50000	100000	500000	1000000	2000000					
2	15,84	21504	21208	20816	18148	11198	9095	7388	1400	88	9439	90,99	33668
	18,90	22948	21636	21220	20536	12672	10292	8360		74	11262	90,99	31667
	22,31	22948	21636	21220	20239	12488	10144	8239		63	11666	79,84	31667
	28,00	22869	21636	21220	19636	12116	9841	7994		50	12116	66,08	31667
	32,55	19475	19195	16711	15947	11988	9737	7909		43	12541	58,84	31667
	39,38	17087	15101	12488	11945	10683	9621	7814		36	10950	42,47	25825
3	55,12	21504	21208	18059	14669	9051	7352	5972	1400	25	11091	31,38	33668
	65,08	21051	20763	20284	16476	10166	8258	6707		22	13093	31,38	32637
	77,65	22948	21636	21220	18644	11504	9344	7590		18	15622	31,38	31667
	80,57	22948	21636	20063	16296	10055	8167	6634		17	13807	26,72	31667
	95,12	22948	21636	21220	18304	11294	9174	7451		15	16300	26,72	31667
	109,04	21437	20280	18847	15829	9767	7933	6444		13	14685	21,00	31667
	119,37	22869	21636	21220	19636	12116	9841	7994		12	18719	24,46	31667
	128,73	22948	21636	21220	17779	10970	8911	7238		11	17337	21,00	31667
	138,77	19475	19195	16711	15947	11988	9737	7909		10	15937	17,91	31667
	157,38	16381	16147	14168	13528	10593	8605	6989		8,9	13636	13,51	27141
	161,54	22869	21636	21220	19636	12116	9841	7994		8,7	20497	19,79	31667
	187,79	19475	19195	16711	15947	11988	9737	7909		7,5	16271	13,51	31667
	201,60	21504	19018	18166	17547	12116	9841	7994		6,9	17870	13,82	31667
	234,36	19475	19195	16711	15947	11988	9737	7909		6,0	16515	10,99	31667
283,50	17087	15101	12488	11945	10683	9621	7814	4,9	12498	6,88	25825		
4	226,46	21051	20763	20284	16476	10166	8258	6707	1400	6,2	18300	12,88	32637
	235,00	21504	21208	18059	14669	9051	7352	5972		6,0	17200	11,66	33668
	270,21	22948	21636	21220	18644	11504	9344	7590		5,2	21000	12,38	31667
	280,40	22948	21636	20063	16296	10055	8167	6634		5,0	20500	11,65	31667
	318,02	20333	17239	16020	13988	8631	7011	5694		4,4	16500	8,27	33668
	331,02	22948	21636	21220	18304	11294	9174	7451		4,2	21300	10,25	31667
	343,50	22948	21636	20063	16296	10055	8167	6634		4,1	20500	9,51	31667
	415,40	22869	21636	21220	19636	12116	9841	7994		3,4	21400	8,21	31667
	447,97	22948	21636	21220	17779	10970	8911	7238		3,1	21400	7,61	31667
	464,85	22948	21636	20063	16296	10055	8167	6634		3,0	20500	7,03	31667
	508,89	22869	21636	21220	19636	12116	9841	7994		2,8	21400	6,70	31667
	562,15	22869	21636	21220	19636	12116	9841	7994		2,5	21400	6,07	31667
	580,13	22948	21636	20063	16296	10055	8167	6634		2,4	21400	5,88	31667
	629,07	21437	20280	18847	15829	9767	7933	6444		2,2	20000	5,07	31667
	688,66	22869	21636	21220	19636	12116	9841	7994		2,0	21600	5,00	31667
	742,65	22948	21636	21220	17779	10970	8911	7238		1,9	21600	4,63	31667
	800,57	19475	19195	16711	15947	11988	9737	7909		1,7	19400	3,86	31667
	859,45	22869	21636	21220	19636	12116	9841	7994		1,6	21700	4,02	31667
	926,83	22948	21636	21220	17779	10970	8911	7238		1,5	21700	3,73	31667
	999,11	19475	19195	16711	15947	11988	9737	7909		1,4	19400	3,09	31667
	1163,08	22869	21636	21220	19636	12116	9841	7994		1,2	22000	3,01	31667
	1352,08	19475	19195	16711	15947	11988	9737	7909		1,0	19400	2,29	31667
1451,52	21504	19018	18166	17547	12116	9841	7994	1,0	21500	2,36	31667		
1687,39	19475	19195	16711	15947	11988	9737	7909	0,8	19500	1,84	31667		
2041,20	17087	15101	12488	11945	10683	9621	7814	0,7	17100	1,33	25825		

P _{TN}	P	PH	PX	R-L-F-FC-FU FB-FCB	FS FP	H HU	X	T
1802	44.4	38.6	43.6	29.9	22.6	26.0	31.0	40.5
1803	28.0	22.5	27.6	19.6	15.3	17.3	20.2	25.8
1804	21.7	19.2	21.4	15.4	12.1	13.6	15.8	20.0

1.2 Prestazioni

1.2 Performances

1.2 Leistungen

Stadio Stage Stufe	ir	n ₂ X h							n ₁ [rpm]	10000 Hours Life				T _{max} [Nm]
		10000	20000	50000	100000	500000	1000000	2000000		n ₂ [rpm]	T _N [Nm]	P ₁ [kW]		
3	40,07	21504	21208	20816	18148	11198	9095	7388	1400	35	12469	50,13	33668	
	47,81	22948	21636	21220	20536	12672	10292	8360		29	14877	50,13	31667	
	56,44	22948	21636	21220	20239	12488	10144	8239		25	15411	43,99	31667	
	70,82	22869	21636	21220	19636	12116	9841	7994		20	16005	36,41	31667	
	78,75	22948	21636	21220	20536	12672	10292	8360		18	17280	35,35	31667	
	82,33	19475	19195	16711	15947	11988	9737	7909		17	15362	30,06	31667	
	92,97	22948	21636	21220	20239	12488	10144	8239		15	17900	31,02	31667	
	99,60	17087	15101	12488	11945	10683	9621	7814		14	11678	18,89	25825	
	116,67	22869	21636	21220	19636	12116	9841	7994		12	15746	21,74	31667	
	135,63	19475	19195	16711	15947	11988	9737	7909		10	15912	18,90	31667	
	153,71	22948	21636	21220	20239	12488	10144	8239		9	20814	21,81	31667	
	164,06	17087	15101	12488	11945	10683	9621	7814		9	12069	11,85	25825	
	192,89	22869	21636	21220	19636	12116	9841	7994		7,3	21051	17,58	31667	
	224,23	19475	19195	16711	15947	11988	9737	7909		6,2	16466	11,83	31667	
271,25	17087	15101	12488	11945	10683	9621	7814	5,2	12463	7,40	25825			
4	158,48	21504	21208	18059	14669	9051	7352	5972	1400	8,8	15225	15,65	33668	
	223,24	22948	21636	21220	18644	11504	9344	7590		6,3	21118	15,41	31667	
	273,47	22948	21636	21220	18304	11294	9174	7451		5,1	21210	12,63	31667	
	343,18	22869	21636	21220	19636	12116	9841	7994		4,1	21313	10,12	31667	
	370,09	22948	21636	21220	17779	10970	8911	7238		3,8	21347	9,40	31667	
	398,95	19475	19195	16711	15947	11988	9737	7909		3,5	17101	6,98	31667	
	454,33	21437	20280	18847	15829	9767	7933	6444		3,1	19591	7,02	31667	
	464,42	22869	21636	21220	19636	12116	9841	7994		3,0	21450	7,52	31667	
	497,37	22869	21636	21220	19636	12116	9841	7994		2,8	21481	7,03	31667	
	536,36	22948	21636	21220	17779	10970	8911	7238		2,6	21515	6,53	31667	
	579,60	21504	19018	18166	17547	12116	9841	7994		2,4	18839	5,29	31667	
	673,08	22869	21636	21220	19636	12116	9841	7994		2,1	21618	5,23	31667	
	782,45	19475	19195	16711	15947	11988	9737	7909		1,8	19240	4,01	31667	
	840,00	21504	19018	18166	17547	12116	9841	7994		1,7	19918	3,86	31667	
	976,50	19475	19195	16711	15947	11988	9737	7909		1,4	19330	3,22	31667	
	1107,69	22869	21636	21220	19636	12116	9841	7994		1,3	22237	3,27	31667	
	1382,40	21504	19018	18166	17547	12116	9841	7994		1,0	21463	2,53	31667	
	1607,04	19475	19195	16711	15947	11988	9737	7909		0,9	19530	1,98	31667	
1944,00	17087	15101	12488	11945	10683	9621	7814	0,7	18027	1,51	25825			

P _{TN}	P	PH	PX	R-L-F-FC-FU FB-FCB	FS FP	H HU	X	T
1803	26,8	22,7	26,5	20,5	17,2	18,7	20,9	25,1
1804	20,0	18,1	19,7	15,4	13,0	14,1	15,7	18,7



1.2 Prestazioni

1.2 Performances

1.2 Leistungen

EX		n ₂ X h							10000 Hours Life				T _{max} [Nm]
Stadio Stage Stufe	ir	10000	20000	50000	100000	500000	1000000	2000000	n ₁ [rpm]	n ₂ [rpm]	T _N [Nm]	P ₁ [kW]	
1	4,40	23010	23010	21238	20922	14786	12010	9755	1400	318	8487	281,49	34800
	5,25	22948	22948	21220	20906	14551	11819	9600		267	8806	250,92	31667
2	15,84	23010	21655	21238	20922	14786	12010	9755	1400	88	12463	120,15	34800
	18,90	22948	21636	21220	20906	14551	11819	9600		74	12933	104,49	31667
	23,47	23010	21655	21238	20094	14786	12010	9755		60	14023	91,25	34800
	28,00	22948	21636	21220	20906	14551	11819	9600		50	14551	79,36	31667
3	67,53	23010	21655	21238	19201	11848	9623	7817	1400	21	15429	35,63	34800
	80,57	22948	21636	21220	20906	13407	10890	8845		17	18410	35,63	31667
	100,04	22948	21636	21220	20906	14786	12010	9755		14	19954	31,11	34800
	119,37	22948	21636	21220	20906	14551	11819	9600		12	20834	27,22	31667
4	235,00	23010	21655	21238	19201	11848	9623	7817	1400	5,96	20000	13,56	34800
	280,40	22948	21636	21220	20906	13407	10890	8845		4,99	21200	12,05	31667
	287,88	23010	21655	21238	19201	11848	9623	7817		4,86	21200	11,73	34800
	343,50	22948	21636	21220	20906	13407	10890	8845		4,08	21500	9,97	31667
	348,15	22948	21636	21220	20906	14786	12010	9755		4,02	21500	9,84	34800
	389,59	23010	21655	21238	19201	11848	9623	7817		3,59	21500	8,79	34800
	415,40	22948	21636	21220	20906	14551	11819	9600		3,37	21500	8,25	31667
	426,50	22948	21636	21220	20906	14786	12010	9755		3,28	21500	8,03	34800
	464,85	22948	21636	21220	20906	13407	10890	8845		3,01	21500	7,37	31667
	486,20	23010	21655	21238	19201	11848	9623	7817		2,88	21500	7,05	34800
	508,89	22948	21636	21220	20906	14551	11819	9600		2,75	21500	6,73	31667
	577,17	22948	21636	21220	20906	14786	12010	9755		2,43	21500	5,94	34800
	580,13	22948	21636	21220	20906	13407	10890	8845		2,41	21500	5,91	31667
	688,66	22948	21636	21220	20906	14551	11819	9600		2,03	21600	5,00	31667
	720,30	22948	21636	21220	20906	14786	12010	9755		1,94	21500	4,76	34800
	859,45	22948	21636	21220	20906	14551	11819	9600		1,63	21800	4,04	31667

P _{TN}	P	PH	PX	R-L-F-FC-FU FB-FCB	FS FP	H HU	X	T
2001	64.9	54.7	63.5	39.6	26.7	32.7	41.5	58.1
2002	44.4	38.6	43.6	29.9	22.6	26.0	31.0	40.5
2003	28.0	22.5	27.6	19.6	15.3	17.3	20.2	25.8
2004	21.7	19.2	21.4	15.4	12.1	13.6	15.8	20.0

1.2 Prestazioni

1.2 Performances

1.2 Leistungen

 Stadio Stage Stufe		$n_2 \times h$							10000 Hours Life				T_{max} [Nm]
		T_N [Nm]							n_1 [rpm]	n_2 [rpm]	T_N [Nm]	P_1 [kW]	
ir	10000	20000	50000	100000	500000	1000000	2000000						
3	40,07	23010	21655	21238	20922	14786	12010	9755	1400	35	16464	66,20	34800
	47,81	22948	21636	21220	20906	14551	11819	9600		29	17084	57,57	31667
	59,36	23010	21655	21238	20094	14786	12010	9755		24	18524	50,27	34800
	70,82	22948	21636	21220	20906	14551	11819	9600		20	18686	42,50	31667
	78,75	22948	21636	21220	20906	14551	11819	9600		18	18801	38,46	31667
	97,78	23010	21655	21238	20094	14786	12010	9755		14	20759	34,20	34800
	116,67	22948	21636	21220	20906	14551	11819	9600		12	20823	28,75	31667
	130,20	22948	21636	21220	20906	14551	11819	9600		11	20873	25,83	31667
	161,66	23010	21655	21238	20094	14786	12010	9755		8,7	20988	20,91	34800
	192,89	22948	21636	21220	20906	14551	11819	9600		7,3	21051	17,58	31667
4	194,14	23010	21655	21238	19201	11848	9623	7817	1400	7,2	21071	17,68	34800
	231,65	22948	21636	21220	20906	13407	10890	8845		6,0	21134	14,86	31667
	281,37	23010	21655	21238	19201	11848	9623	7817		5,0	21240	12,30	34800
	287,62	22948	21636	21220	20906	14786	12010	9755		4,9	21233	12,02	34800
	335,72	22948	21636	21220	20906	13407	10890	8845		4,2	21303	10,34	31667
	343,18	22948	21636	21220	20906	14551	11819	9600		4,1	21313	10,12	31667
	416,84	22948	21636	21220	20906	14786	12010	9755		3,4	21401	8,36	34800
	463,05	23010	21655	21238	19201	11848	9623	7817		3,0	21467	7,55	34800
	497,37	22948	21636	21220	20906	14551	11819	9600		2,8	21481	7,03	31667
	552,51	22948	21636	21220	20906	13407	10890	8845		2,5	21529	6,35	31667
	686,00	22948	21636	21220	20906	14786	12010	9755		2,0	21627	5,14	34800
	818,53	22948	21636	21220	20906	14551	11819	9600		1,7	21707	4,32	31667

B

P_{tN}	P	PH	PX	R-L-F-FC-FU FB-FCB	FS FP	H HU	X	T
2003	26,8	22,7	26,5	20,5	17,2	18,7	20,9	25,1
2004	20,0	18,1	19,7	15,4	13,0	14,1	15,7	18,7



1.2 Prestazioni

1.2 Performances

1.2 Leistungen

EX 	n ₂ X h								10000 Hours Life				T _{max} [Nm]
	Stadio Stage Stufe	ir	10000	20000	50000	100000	500000	1000000	2000000	n ₁ [rpm]	n ₂ [rpm]	T _N [Nm]	
1	3.63	26102	24645	24086	23542	16856	13691	11121	1400	386	9128	376.69	54400
	4.00	32628	30807	30108	26912	16606	13488	10956		350	9263	346.40	55200
	5.20	31767	29519	29041	26516	16361	13290	10795		269	9874	284.03	40400
	6.25	25999	24178	23770	21693	16050	13036	10589		224	10235	244.96	38800
2	12.69	25780	24645	23739	19282	11898	9664	7850	1400	110	9383	112.93	42456
	14.00	28384	27940	25433	20658	12747	10353	8410		100	10353	112.93	46848
	16.50	27734	27387	25226	20490	12643	10269	8341		85	10788	99.84	41851
	18.20	31767	29519	29041	24823	15316	12441	10105		77	13460	112.93	40400
	21.45	31767	29519	29041	24621	15192	12340	10023		65	14025	99.84	40400
	26.87	30686	29519	29041	23933	14767	11995	9743		52	14585	82.90	40400
	31.20	29921	29288	24389	23295	14442	11731	9528		45	14919	73.02	40400
	37.70	25044	22124	18235	17429	14307	11621	9439		37	15642	63.36	40400
45.31	25999	24178	21660	20691	16050	13036	10589	31	17824	60.07	38800		
3	50.40	28384	27940	25433	20658	12747	10353	8410	1400	28	15205	47.05	46848
	59.40	27734	27387	25226	20490	12643	10269	8341		24	15843	41.60	41851
	70.13	27734	27387	25226	20490	12643	10269	8341		20	16652	37.03	41851
	77.35	31767	29519	29041	24823	15316	12441	10105		18	20775	41.89	40400
	87.83	23729	23399	22963	19917	12290	9982	8108		16	17318	30.75	40602
	102.30	27734	25785	24244	20490	12643	10269	8341		14	18650	28.43	41851
	114.18	30686	29519	29041	23933	14767	11995	9743		12	22513	30.75	40400
	132.60	29921	29288	24389	23295	14442	11731	9528		11	23027	27.08	40400
	143.29	30686	29519	29041	23933	14767	11995	9743		10	24100	26.23	40400
	166.57	30686	29519	29041	23933	14767	11995	9743		8.4	25213	23.61	40400
	193.44	29921	29288	24389	23295	14442	11731	9528		7.2	23806	19.19	40400
	201.50	30686	29519	28718	23933	14767	11995	9743		6.9	26695	20.66	40400
	233.74	25044	22124	18235	17429	14307	11621	9439		6.0	18025	12.03	40400
	242.19	25999	24178	23770	21693	16050	13036	10589		5.8	23705	15.26	38800
282.75	25044	22124	18235	17429	14307	11621	9439	5.0	18246	10.06	40400		
339.84	25999	24178	21660	20691	16050	13036	10589	4.1	21930	10.06	38800		
4	207.06	27734	27387	25226	20490	12643	10269	8341	1400	6.8	23043	17.73	41851
	214.86	28384	27940	25433	20658	12747	10353	8410		6.5	23491	17.42	46848
	244.04	27734	27387	25226	20490	12643	10269	8341		5.7	24027	15.69	41851
	298.95	27734	27387	25226	20490	12643	10269	8341		4.7	25727	13.71	41851
	306.24	27734	27387	25226	20490	12643	10269	8341		4.6	25913	13.48	41851
	342.69	27734	27387	25226	20490	12643	10269	8341		4.1	26803	12.46	41851
	404.57	27734	27387	25226	20490	12643	10269	8341		3.5	27113	10.68	41851
	445.50	31767	29519	29041	24621	15192	12340	10023		3.1	29283	10.47	40400
	558.00	30686	29519	29041	23933	14767	11995	9743		2.5	29401	8.40	40400
	633.60	27734	27387	25226	20490	12643	10269	8341		2.2	27338	6.88	41851
	698.88	31767	29519	29041	24823	15316	12441	10105		2.0	29518	6.73	40400
	824.67	29921	29288	24389	23295	14442	11731	9528		1.7	29598	5.72	40400
	961.00	30686	29519	29041	23933	14767	11995	9743		1.5	30259	5.02	40400
	1031.68	30686	29519	29041	23933	14767	11995	9743		1.4	30497	4.71	40400
	1162.50	30686	29519	28718	23933	14767	11995	9743		1.2	30570	4.19	40400
	1350.00	29921	29288	24389	23295	14442	11731	9528		1.0	29898	3.53	40400
	1450.80	30686	29519	28718	23933	14767	11995	9743		1.0	30708	3.37	40400
	1684.80	29921	29288	24389	23295	14442	11731	9528		0.8	30000	2.84	40400
	2035.80	25044	22124	18235	17429	14307	11621	9439		0.7	26621	2.08	40400
	2446.88	25999	24178	21660	20691	16050	13036	10589		0.6	27948	1.82	38800

P _{TN}	PH	FCB	FS FP	H HU	T
2501	61.8	41.8	33.4	36.6	57.1
2502	45.4	34.0	29.2	31.0	42.7
2503	26.5	22.5	19.7	20.8	27.6
2504	22.5	17.5	15.4	16.2	21.4

1.2 Prestazioni

1.2 Performances

1.2 Leistungen

Stadio Stage Stufe	ir	$n_2 \times h$							10000 Hours Life				T_{max} [Nm]
		10000	20000	50000	100000	500000	1000000	2000000	n_1 [rpm]	n_2 [rpm]	T_N [Nm]	P_1 [kW]	
3	32,09	25780	24645	23739	19282	11898	9664	7850	1400	44	12395	62,22	42456
	35,41	28384	27940	25433	20658	12747	10353	8410		40	13677	62,22	46848
	46,04	31767	29519	29041	24823	15316	12441	10105		30	17780	62,22	40400
	54,26	31767	29519	29041	24621	15192	12340	10023		26	18527	55,01	40400
	67,96	30686	29519	29041	23933	14767	11995	9743		21	19267	45,67	40400
	78,92	29921	29288	24389	23295	14442	11731	9528		18	19708	40,23	40400
	96,44	28384	27940	25433	20658	12747	10353	8410		15	18473	30,86	46848
	111,94	30686	29519	29041	23933	14767	11995	9743		13	22380	32,21	40400
	130,00	29921	29288	24389	23295	14442	11731	9528		11	22891	28,37	40400
	147,77	31767	29519	29041	24621	15192	12340	10023		9,5	25023	27,28	40400
	185,08	30686	29519	29041	23933	14767	11995	9743		7,6	26023	22,65	40400
	214,93	29921	29288	24389	23295	14442	11731	9528		6,5	23972	17,97	40400
	259,71	25044	22124	18235	17429	14307	11621	9439		5,4	18147	11,26	40400
	312,15	25999	24178	21660	20691	16050	13036	10589		4,5	21811	11,26	38800
4	144,90	28384	27940	25433	20658	12747	10353	8410	1400	9,7	20872	23,46	46848
	170,78	27734	27387	25226	20490	12643	10269	8341		8,2	21749	20,74	41851
	222,38	31767	29519	29041	24823	15316	12441	10105		6,3	28519	20,89	40400
	252,52	23729	23399	22963	19917	12290	9982	8108		5,5	22914	14,78	40602
	328,28	30686	29519	29041	23933	14767	11995	9743		4,3	29124	14,45	40400
	381,23	29921	29288	24389	23295	14442	11731	9528		3,7	24876	10,63	40400
	411,96	30686	29519	29041	23933	14767	11995	9743		3,4	29242	11,56	40400
	478,90	30686	29519	29041	23933	14767	11995	9743		2,9	29321	9,97	40400
	552,50	29921	29288	24389	23295	14442	11731	9528		2,5	27989	8,25	40400
	579,31	30686	29519	28718	23933	14767	11995	9743		2,4	29420	8,27	40400
	694,06	30686	29519	29041	23933	14767	11995	9743		2,0	29514	6,93	40400
	782,97	30686	29519	29041	23933	14767	11995	9743		1,8	29577	6,15	40400
	839,58	30686	29519	28718	23933	14767	11995	9743		1,7	29614	5,75	40400
	982,55	25999	24178	21660	20691	16050	13036	10589		1,4	30347	5,03	38800
	1142,22	30686	29519	29041	23933	14767	11995	9743		1,2	30560	4,36	40400
	1381,71	30686	29519	28718	23933	14767	11995	9743		1,0	30677	3,62	40400
	1660,71	25999	24178	23770	21693	16050	13036	10589		0,8	26595	2,61	38800
	1938,86	25044	22124	18235	17429	14307	11621	9439		0,7	26416	2,22	40400
2330,36	25999	24178	21660	20691	16050	13036	10589	0,6	27778	1,94	38800		

B

P_{TN}	PH	FCB	FS FP	H HU	T
2503	25,6	22,6	20,5	21,3	26,5
2504	20,6	16,9	15,4	16,0	19,7



1.2 Prestazioni

1.2 Performances

1.2 Leistungen

EX 	n ₂ X h								10000 Hours Life				T _{max} [Nm]
	Stadio Stage Stufe	ir	T _N [Nm]						n ₁ [rpm]	n ₂ [rpm]	T _N [Nm]	P ₁ [kW]	
10000			20000	50000	100000	500000	1000000	2000000					
2	12,69	26102	24645	24086	23542	16309	13247	10760	1400	110	12862	154,80	54400
	14,00	32628	30807	30108	26912	16606	13488	10956		100	13488	147,12	55200
	16,50	32628	30807	30108	26912	16606	13488	10956		85	14170	131,14	55200
	18,20	31767	29519	29041	26516	16361	13290	10795		77	14378	120,64	40400
	21,45	31767	29519	29041	26516	16361	13290	10795		65	15104	107,53	40400
	26,87	31767	29519	29041	26516	16361	13290	10795		52	16160	91,85	40400
	31,20	31767	29519	29041	26516	16361	13290	10795		45	16901	82,72	40400
	37,70	31767	29519	24558	23390	16361	13290	10795		37	17889	72,46	40400
	45,31	25999	24178	23770	21693	16050	13036	10589		31	17824	60,07	38800
3	50,40	32628	30807	30108	26912	16606	13488	10956	1400	28	19808	61,29	55200
	59,40	32628	30807	30108	26912	16606	13488	10956		24	20809	54,63	55200
	70,13	32628	30807	30108	26912	16606	13488	10956		20	21871	48,64	55200
	77,35	31767	29519	29041	26516	16361	13290	10795		18	22193	44,75	40400
	87,83	32503	30807	30108	26912	16606	13488	10956		16	23400	41,55	55200
	102,30	28781	25785	24244	23078	16606	13488	10956		14	22551	34,38	55200
	114,18	31767	29519	29041	26516	16361	13290	10795		12	24943	34,07	40400
	132,60	31767	29519	29041	26516	16361	13290	10795		11	26088	30,68	40400
	143,29	31767	29519	29041	26516	16361	13290	10795		10	26702	29,06	40400
	166,57	31767	29519	29041	26516	16361	13290	10795		8,4	27935	26,15	40400
	193,44	31767	29519	29041	26516	16361	13290	10795		7,2	28848	23,26	40400
	201,50	31767	29519	28718	26516	16361	13290	10795		6,9	28054	21,71	40400
	233,74	31767	29519	24558	23390	16361	13290	10795		6,0	24254	16,18	40400
	242,19	25999	24178	23770	21693	16050	13036	10589		5,8	23705	15,26	38800
	282,75	31767	29519	24558	23390	16361	13290	10795		5,0	24575	13,55	40400
339,84	25999	24178	23770	21693	16050	13036	10589	4,1	23856	10,95	38800		
4	207,06	32628	30807	30108	26912	16606	13488	10956	1400	6,8	29442	22,66	55200
	214,86	32628	30807	30108	26912	16606	13488	10956		6,5	29524	21,90	55200
	244,04	32628	30807	30108	26912	16606	13488	10956		5,7	29804	19,46	55200
	298,95	32628	30807	30108	26912	16606	13488	10956		4,7	30232	16,11	55200
	306,24	32628	30807	30108	26912	16606	13488	10956		4,6	30248	15,74	55200
	342,69	32628	30807	30108	26912	16606	13488	10956		4,1	30324	14,10	55200
	404,57	32628	30807	30108	26912	16606	13488	10956		3,5	30436	11,99	55200
	445,50	31767	29519	29041	26516	16361	13290	10795		3,1	29283	10,47	40400
	558,00	30686	29519	29041	23933	14767	11995	9743		2,5	29401	8,40	40400
	633,60	32628	30807	30108	26912	16606	13488	10956		2,2	30379	7,64	55200
	698,88	31767	29519	29041	24823	15316	12441	10105		2,0	29518	6,73	40400
	824,67	31767	29519	29041	26516	16361	13290	10795		1,7	29604	5,72	40400
	961,00	31767	29519	29041	26516	16361	13290	10795		1,5	30259	5,02	40400
	1031,68	31767	29519	29041	26516	16361	13290	10795		1,4	30543	4,72	40400
	1162,50	31767	29519	28718	26516	16361	13290	10795		1,2	31022	4,25	40400
	1350,00	29921	29288	24389	23295	14442	11731	9528		1,0	31621	3,73	40400
	1450,80	31767	29519	28718	26516	16361	13290	10795		1,0	31910	3,50	40400
	1684,80	31767	29519	29041	26516	16361	13290	10795		0,8	32509	3,07	40400
	2035,80	31767	29519	24558	23390	16361	13290	10795		0,7	33268	2,60	40400
	2446,88	25999	24178	23770	21693	16050	13036	10589		0,6	27948	1,82	38800

P _{EN}	PH	FCB	FS FP	H HU	T
2802	46.3	34.9	30.1	31.9	43.6
2803	27.0	23.5	20.7	21.7	28.6
2804	23.3	18.3	16.2	17.0	22.1

1.2 Prestazioni

1.2 Performances

1.2 Leistungen

Stadio Stage Stufe	ir	n ₂ X h							10000 Hours Life				T _{max} [Nm]
		10000	20000	50000	100000	500000	1000000	2000000	n ₁ [rpm]	n ₂ [rpm]	T _N [Nm]	P ₁ [kW]	
3	32,09	26102	24645	24086	23542	16309	13247	10760	1400	44	16990	85,29	54400
	35,41	32628	30807	30108	26912	16606	13488	10956		40	17818	81,06	55200
	46,04	31767	29519	29041	26516	16361	13290	10795		30	18993	66,46	40400
	54,26	31767	29519	29041	26516	16361	13290	10795		26	19953	59,24	40400
	67,96	31767	29519	29041	26516	16361	13290	10795		21	21347	50,60	40400
	78,92	31767	29519	29041	26516	16361	13290	10795		18	22327	45,58	40400
	96,44	32628	30807	30108	26912	16606	13488	10956		15	24066	40,20	55200
	111,94	31767	29519	29041	26516	16361	13290	10795		13	24796	35,68	40400
	130,00	31767	29519	29041	26516	16361	13290	10795		11	25933	32,14	40400
	147,77	31767	29519	29041	26516	16361	13290	10795		9,5	26949	29,38	40400
	185,08	31767	29519	29041	26516	16361	13290	10795		7,6	28825	25,09	40400
	214,93	31767	29519	29041	26516	16361	13290	10795		6,5	28903	21,66	40400
	259,71	31767	29519	24558	23390	16361	13290	10795		5,4	24432	15,15	40400
	312,15	25999	24178	23770	21693	16050	13036	10589		4,5	23818	12,29	38800
4	127,48	32628	30807	30108	26912	16606	13488	10956	1400	11,0	26167	33,43	55200
	150,25	32628	30807	30108	26912	16606	13488	10956		9,3	27489	29,80	55200
	177,38	32628	30807	30108	26912	16606	13488	10956		7,9	28892	26,53	55200
	222,17	32503	30807	30108	26912	16606	13488	10956		6,3	29597	21,70	55200
	258,76	28781	25785	24244	23078	16606	13488	10956		5,4	24111	15,18	55200
	335,40	31767	29519	29041	26516	16361	13290	10795		4,2	29135	14,15	40400
	362,44	31767	29519	29041	26516	16361	13290	10795		3,9	29175	13,11	40400
	421,33	31767	29519	29041	26516	16361	13290	10795		3,3	29254	11,31	40400
	489,29	31767	29519	29041	26516	16361	13290	10795		2,9	29332	9,76	40400
	552,50	31767	29519	29041	26516	16361	13290	10795		2,5	29395	8,67	40400
	597,04	31767	29519	29041	26516	16361	13290	10795		2,3	29436	8,03	40400
	694,06	31767	29519	29041	26516	16361	13290	10795		2,0	29514	6,93	40400
	786,60	31767	29519	29041	26516	16361	13290	10795		1,8	29580	6,13	40400
	839,58	31767	29519	28718	26516	16361	13290	10795		1,7	29614	5,75	40400
	987,10	31767	29519	29041	26516	16361	13290	10795		1,4	30366	5,01	40400
	1147,51	31767	29519	29041	26516	16361	13290	10795		1,2	30970	4,40	40400
	1388,11	31767	29519	28718	26516	16361	13290	10795		1,0	31733	3,72	40400
	1610,21	31767	29519	24558	23390	16361	13290	10795		0,9	32328	3,27	40400
	1668,40	25999	24178	23770	21693	16050	13036	10589		0,8	26612	2,60	38800
	1947,83	31767	29519	24558	23390	16361	13290	10795		0,7	33091	2,77	40400
2341,15	25999	24178	23770	21693	16050	13036	10589	0,6	27794	1,93	38800		

B

P _{TN}	PH	FCB	FS FP	H HU	T
2803	26,0	23,4	21,3	22,1	27,2
2804	21,1	17,5	16,0	16,5	20,3



1.2 Prestazioni

1.2 Performances

1.2 Leistungen

EX		n ₂ X h							10000 Hours Life				T _{max} [Nm]
Stadio Stage Stufe	ir	10000	20000	50000	100000	500000	1000000	2000000	n ₁ [rpm]	n ₂ [rpm]	T _N [Nm]	P ₁ [kW]	
1	3,52	32282	30462	29353	28644	22474	18255	14827	1400	398	12064	512,69	77273
	4,00	40352	38077	36691	35805	22141	17984	14608		350	12350	461,86	69565
	4,71	38455	37838	37021	35841	22115	17963	14591		298	12952	411,71	64545
2	12,32	32282	30462	29353	25893	15977	12977	10541	1400	114	12489	154,80	60465
	14,00	38826	38077	34862	28317	17473	14192	11528		100	14192	154,80	68710
	16,47	38455	37838	37021	31729	19578	15902	12916		85	16697	154,80	64545
	19,41	38455	37838	37021	31471	19419	15773	12812		72	17398	136,86	64545
	24,31	38109	37555	36823	30591	18876	15332	12453		58	18093	113,64	64545
	28,24	37273	36713	30476	29018	18460	14994	12179		50	18507	100,09	64545
	34,12	31688	27858	22377	21320	18287	14854	12065		41	19167	85,79	57687
3	44,35	31689	30462	29353	25893	15977	12977	10541	1400	32	18341	64,49	60465
	50,40	35920	35431	34784	28317	17473	14192	11528		28	20842	64,49	68710
	59,29	38455	37838	37021	31729	19578	15902	12916		24	24520	64,49	64545
	70,00	38455	37838	37021	31729	19578	15902	12916		20	25772	57,42	64545
	82,50	38455	37838	37021	31471	19419	15773	12812		17	26854	50,76	64545
	87,53	38109	37555	36823	30591	18876	15332	12453		16	26571	47,34	64545
	101,65	37273	36713	30476	29018	18460	14994	12179		14	27178	41,70	64545
	110,22	32503	32033	31410	27302	16846	13683	11114		13	25412	35,95	57779
	120,00	37273	36713	30476	29018	18460	14994	12179		12	28566	37,12	64545
	129,67	38109	37555	36823	30591	18876	15332	12453		11	29896	35,95	64545
	150,75	38109	37035	34764	30591	18876	15332	12453		9,3	31277	32,36	64545
	175,06	37273	36713	30476	29018	18460	14994	12179		8,0	29488	26,27	64545
	211,76	33486	32017	30075	28606	18460	14994	12179		6,6	29483	21,71	64545
255,88	31688	27858	22377	21320	18287	14854	12065	5,5	22240	13,55	57687		
4	206,34	38455	37838	37021	31729	19578	15902	12916	1400	6,8	35644	27,53	64545
	214,86	35920	35431	34784	28317	17473	14192	11528		6,5	32200	23,88	68710
	243,60	38455	37838	37021	31729	19578	15902	12916		5,7	37000	24,20	64545
	298,42	38455	37838	37021	31729	19578	15902	12916		4,7	37100	19,81	64545
	304,60	38109	37555	36823	30591	18876	15332	12453		4,6	37000	19,36	64545
	342,08	38455	37838	37021	31729	19578	15902	12916		4,1	37200	17,33	64545
	403,85	38455	37838	37021	31729	19578	15902	12916		3,5	37500	14,80	64545
	451,26	38109	37555	36823	30591	18876	15332	12453		3,1	37200	13,14	64545
	504,98	38109	37555	36823	30591	18876	15332	12453		2,8	37300	11,77	64545
	552,82	38109	37555	36823	30591	18876	15332	12453		2,5	37400	10,78	64545
	630,21	38109	37555	36823	30591	18876	15332	12453		2,2	37500	9,48	64545
	736,94	33486	32017	36823	28606	18460	14994	12179		1,9	32200	6,96	64545
	775,73	31688	27858	22377	21320	18287	14854	12065		1,8	28400	5,83	57687
	869,68	38109	37035	34764	30591	18876	15332	12453		1,6	37500	6,87	64545
	933,65	38109	37555	36823	30591	18876	15332	12453		1,5	37800	6,45	64545
	1085,36	35920	35431	34784	28317	17473	14192	11528		1,3	37900	5,56	68710
	1260,42	37273	36713	30476	29018	17473	14994	12179		1,1	37200	4,70	64545
	1310,12	31688	27858	22377	21320	18287	14854	12065		1,1	31300	3,81	57687
	1524,71	33486	32017	30075	28606	18460	14994	12179		0,9	33700	3,52	64545
	1842,35	31688	27858	22377	21320	18287	14854	12065		0,8	33200	2,87	57687

P _{EN}	PH	FS FP	H HU	T
3001	64.3	32.7	36.6	73.7
3002	47.7	29.6	31.9	53.1
3003	27.8	20.4	21.7	34.1
3004	23.9	16.0	17.0	26.2

1.2 Prestazioni

1.2 Performances

1.2 Leistungen

Stadio Stage Stufe	ir	n ₂ X h							10000 Hours Life				T _{max} [Nm]
		10000	20000	50000	100000	500000	1000000	2000000	n ₁ [rpm]	n ₂ [rpm]	T _N [Nm]	P ₁ [kW]	
3	31,16	32282	30462	29353	25893	15977	12977	10541	1400	45	16498	85,29	60465
	35,41	38826	38077	34862	28317	17473	14192	11528		40	18748	85,29	68710
	41,66	38455	37838	37021	31729	19578	15902	12916		34	22056	85,29	64545
	49,10	38455	37838	37021	31471	19419	15773	12812		29	22983	75,41	64545
	61,50	38109	37555	36823	30591	18876	15332	12453		23	23901	62,61	64545
	71,42	37273	36713	30476	29018	18460	14994	12179		20	24447	55,14	64545
	80,88	38455	27858	22377	21320	18287	14854	12065		17	26695	53,17	57687
	101,31	38109	37555	36823	30591	18876	15332	12453		14	27762	44,15	64545
	117,65	37273	36713	30476	29018	18460	14994	12179		12	28396	38,88	64545
	133,73	38455	37838	37021	31471	19419	15773	12812		10,5	31041	37,39	64545
	142,16	31688	27858	22377	21320	18287	14854	12065		9,8	21343	24,19	57687
	167,49	38109	37555	36823	30591	18876	15332	12453		8,4	32282	31,05	64545
	194,51	37273	36713	30476	29018	18460	14994	12179		7,2	29710	24,61	64545
	235,03	31688	27858	22377	21320	18287	14854	12065		6,0	22110	15,15	57687
4	127,48	35920	35431	34784	28317	17473	14192	11528	1400	11,0	27532	35,18	68710
	149,98	38455	37838	37021	31729	19578	15902	12916		9,3	32391	35,18	64545
	177,06	38455	37838	37021	31729	19578	15902	12916		7,9	34045	31,32	64545
	221,40	38109	37555	36823	30591	18876	15332	12453		6,3	35100	25,82	64545
	257,11	37273	36713	30476	29018	18460	14994	12179		5,4	30297	19,19	64545
	328,00	38109	37555	36823	30591	18876	15332	12453		4,3	36950	18,35	64545
	364,71	38109	37555	36823	30591	18876	15332	12453		3,8	37034	16,54	64545
	381,30	38109	37035	34764	30591	18876	15332	12453		3,7	35530	15,18	64545
	423,53	37273	36713	30476	29018	18460	14994	12179		3,3	33870	13,03	64545
	442,80	37273	36713	30476	29018	18460	14994	12179		3,2	34196	12,58	64545
	500,00	37273	36713	30476	29018	18460	14994	12179		2,8	35086	11,43	64545
	540,31	38109	37555	36823	30591	18876	15332	12453		2,6	37349	11,26	64545
	628,10	38109	37035	34764	30591	18876	15332	12453		2,2	36767	9,53	64545
	729,41	37273	36713	30476	29018	18460	14994	12179		1,9	36746	8,21	64545
	826,67	37273	36713	30476	29018	18460	14994	12179		1,7	36874	7,27	64545
	893,30	38109	37555	36823	30591	18876	15332	12453		1,6	37750	6,88	64545
	1038,47	38109	37035	34764	30591	18876	15332	12453		1,3	37871	5,94	64545
	1205,96	37273	36713	30476	29018	18460	14994	12179		1,2	37153	5,02	64545
	1458,82	33486	32017	30075	28606	18460	14994	12179		1,0	33574	3,75	64545
1762,75	31688	27858	22377	21320	18287	14854	12065	0,8	32961	3,05	57687		

B

P _{tn}	PH	FS FP	H HU	T
3003	26,6	21,1	22,1	31,3
3004	21,6	15,8	16,5	23,3



1.2 Prestazioni

1.2 Performances

1.2 Leistungen

EX 	n ₂ X h								10000 Hours Life				T _{max} [Nm]
	Stadio Stage Stufe	ir	T _N [Nm]						n ₁ [rpm]	n ₂ [rpm]	T _N [Nm]	P ₁ [kW]	
1			4,04	42343	38760	38114	37626	25123					20406
	5,12	39959	39259	38332	37632	24631	20007	16250	274	14793	432,40	68182	
	6,00	37308	36685	35861	35238	24141	19609	15927	233	15208	379,15	65909	
	7,36	36233	33413	31612	28709	22987	19414	15769	190	16010	325,24	51364	
2	14,15	39238	38598	37752	31385	19366	15730	12777	1400	99	15781	170,28	69457
	17,91	39959	39259	38332	37012	22838	18550	15067		78	19973	170,28	68182
	21,11	39959	39259	38332	36712	22652	18399	14945		66	20812	150,55	68182
	26,44	39959	39259	38332	35685	22019	17885	14527		53	21644	125,00	68182
	30,71	39959	39259	32951	31365	21534	17491	14207		46	22139	110,10	68182
	36,00	37308	37308	37308	36347	24071	19551	15881		39	25956	110,10	65909
	43,50	37308	33808	28058	26711	23582	19368	15732		32	24438	85,79	65909
	53,39	36233	33413	31612	28709	22987	19414	15769		26	23971	68,57	51364
3	50,95	39238	38598	37752	31385	19366	15730	12777	1400	27	23175	70,94	69457
	64,48	39959	39259	38332	37012	22838	18550	15067		22	29332	70,94	68182
	76,13	39959	39259	38332	37012	22838	18550	15067		18	30829	63,16	68182
	89,72	39959	39259	38332	36712	22652	18399	14945		16	32124	55,84	68182
	95,53	39959	39259	38332	37012	22838	18550	15067		15	33003	53,88	68182
	112,59	39959	39259	38332	36712	22652	18399	14945		12	34389	47,63	68182
	130,88	39959	39259	38332	36712	22652	18399	14945		11	35978	42,87	68182
	158,33	39959	39259	38332	36712	22652	18399	14945		8,8	37756	37,19	68182
	163,94	39959	39259	38332	35685	22019	17885	14527		8,5	37416	35,59	68182
	190,38	39959	39259	32951	31365	21534	17491	14207		7,4	32069	26,27	68182
	198,31	39959	39259	38332	35685	22019	17885	14527		7,1	37984	29,87	68182
	230,29	39959	39259	32951	31365	21534	17491	14207		6,1	32504	22,01	68182
	270,00	37308	37308	37308	36347	24071	19551	15881		5,2	37308	21,55	65909
	284,73	36233	33413	31612	28709	22987	19414	15769		4,9	31686	17,36	51364
331,00	36233	33413	31612	28709	22987	19414	15769	4,2	32356	15,25	51364		
4	209,31	39238	38598	37752	31385	19366	15730	12777	1400	6,7	32191	24,51	69457
	224,40	39959	39259	38332	37012	22838	18550	15067		6,2	38109	27,06	68182
	264,92	39959	39259	38332	37012	22838	18550	15067		5,3	38276	23,02	68182
	312,22	39959	39259	38332	36712	22652	18399	14945		4,5	38442	19,62	68182
	324,53	39959	39259	38332	37012	22838	18550	15067		4,3	38482	18,89	68182
	372,01	39959	39259	38332	37012	22838	18550	15067		3,8	38620	16,54	68182
	382,49	39959	39259	38332	36712	22652	18399	14945		3,7	38648	16,10	68182
	391,81	39959	39259	38332	36712	22652	18399	14945		3,6	38672	15,73	68182
	439,18	39959	39259	38332	37012	22838	18550	15067		3,2	38787	14,07	68182
	455,48	39959	39259	38332	36712	22652	18399	14945		3,1	38824	13,58	68182
	517,61	39959	39259	38332	36712	22652	18399	14945		2,7	38953	11,99	68182
	548,10	39959	39259	38332	37012	22838	18550	15067		2,6	39011	11,34	68182
	649,55	39959	39259	38332	36712	22652	18399	14945		2,2	39183	9,61	68182
	698,88	39959	39259	38332	35685	22019	17885	14527		2,0	39257	8,95	68182
	755,10	39959	39259	38332	36712	22652	18399	14945		1,9	39335	8,30	68182
	810,64	39959	39259	38332	36712	22652	18399	14945		1,7	39407	7,75	68182
	913,43	39959	39259	38332	36712	22652	18399	14945		1,5	39528	6,90	68182
	1098,33	39959	39259	32951	31365	21534	17491	14207		1,3	39714	5,76	68182
	1328,62	39959	39259	32951	31365	21534	17491	14207		1,1	39907	4,79	68182
	1427,82	39959	39259	38332	35685	22019	17885	14527		1,0	39979	4,46	68182
	1658,12	39959	39259	32951	31365	21534	17491	14207		0,8	40610	3,90	68182
	1944,00	37308	37308	37308	36347	24071	19551	15881		0,7	37308	3,06	65909
	2383,17	36233	33413	31612	28709	22987	19414	15769		0,6	38672	2,59	51364
	2882,86	36233	33413	31612	28709	22987	19414	15769		0,5	39545	2,19	51364

P _{EN}	PS PSB	S-SB-SU FS-FSB
3501	91.3	47.9
3502	54.1	35.5
3503	34.7	23.8
3504	27.6	19.5

1.2 Prestazioni

1.2 Performances

1.2 Leistungen

 Stadio Stage Stufe		n ₂ X h							10000 Hours Life				T _{max} [Nm]
		T _N [Nm]							n ₁ [rpm]	n ₂ [rpm]	T _N [Nm]	P ₁ [kW]	
ir	10000	20000	50000	100000	500000	1000000	2000000						
3	35,80	39238	38598	37752	31385	19366	15730	12777	1400	39	20847	93,82	69457
	53,40	39959	39259	38332	36712	22652	18399	14945		26	27493	82,95	68182
	66,88	39959	39259	38332	35685	22019	17885	14527		21	28592	68,87	68182
	77,67	39959	39259	32951	31365	21534	17491	14207		18	29245	60,66	68182
	87,96	39959	39259	38332	36712	22652	18399	14945		16	31394	57,50	68182
	110,17	39959	39259	38332	35685	22019	17885	14527		13	33210	48,56	68182
	127,94	39959	39259	32951	31365	21534	17491	14207		11	31159	39,23	68182
	145,43	39959	39259	38332	36712	22652	18399	14945		10	37133	41,13	68182
	182,15	39959	39259	38332	35685	22019	17885	14527		8	37898	33,52	68182
	211,53	39959	39259	32951	31365	21534	17491	14207		7	32310	24,61	68182
	248,00	37308	37308	37308	36347	24071	19551	15881		5,6	32406	21,05	65909
	299,67	37308	33808	28058	26711	23582	19368	15732		4,7	28190	15,15	65909
	367,77	36233	33413	31612	28709	22987	19414	15769		3,8	32834	14,38	51364
4	128,87	39238	38598	37752	31385	19366	15730	12777	1400	10,9	30615	38,70	69457
	163,10	39959	39259	38332	37012	22838	18550	15067		8,6	37786	37,74	68182
	192,55	39959	39259	38332	37012	22838	18550	15067		7,3	37954	32,11	68182
	226,94	39959	39259	38332	36712	22652	18399	14945		6,2	38120	27,36	68182
	241,63	39959	39259	38332	37012	22838	18550	15067		5,8	38183	25,74	68182
	331,06	39959	39259	38332	36712	22652	18399	14945		4,2	38502	18,94	68182
	373,83	39959	39259	38332	36712	22652	18399	14945		3,7	38624	16,83	68182
	414,66	39959	39259	38332	35685	22019	17885	14527		3,4	38729	15,21	68182
	469,12	39959	39259	38332	36712	22652	18399	14945		3,0	38854	13,49	68182
	501,60	39959	39259	38332	35685	22019	17885	14527		2,8	38922	12,64	68182
	545,35	39959	39259	38332	36712	22652	18399	14945		2,6	39000	11,65	68182
	659,70	39959	39259	38332	36712	22652	18399	14945		2,1	39200	9,68	68182
	775,61	39959	39259	38332	36712	22652	18399	14945		1,8	39362	8,27	68182
	826,29	39959	39259	38332	35685	22019	17885	14527		1,7	39426	7,77	68182
	901,64	39959	39259	38332	36712	22652	18399	14945		1,6	39515	7,14	68182
	1090,70	39959	39259	38332	36712	22652	18399	14945		1,3	39707	5,93	68182
	1366,13	39959	39259	38332	35685	22019	17885	14527		1,0	39935	4,76	68182
	1586,47	39959	39259	32951	31365	21534	17491	14207		0,9	40571	4,17	68182
	1860,00	32406	32406	32406	32406	24071	19551	15881		0,8	32406	2,84	65909
	1961,45	36233	33413	31612	28709	22987	19414	15769		0,7	37779	3,14	51364
2280,19	36233	33413	31612	28709	22987	19414	15769	0,6	38470	2,75	51364		

B

P _{TN}	PS PSB	S-SB-SU FS-FSB
3503	28,3	21,0
3504	24,3	18,4



1.2 Prestazioni

1.2 Performances

1.2 Leistungen

EX 	n ₂ X h								10000 Hours Life				T _{max} [Nm]
	Stadio Stage Stufe	ir	10000	20000	50000	100000	500000	1000000	2000000	n ₁ [rpm]	n ₂ [rpm]	T _N [Nm]	
1	4,18	49268	46410	45531	44866	30452	24735	20091	1400	335	17214	615,76	88135
	4,89	50202	46457	45659	45056	29855	24250	19697		286	17686	541,16	84609
	6,00	46515	42430	41734	41207	29427	23902	19415		233	18537	462,16	80093
2	15,56	49268	46410	45531	44866	29832	24231	19682	1400	90	25009	245,50	88135
	17,11	49268	46410	45531	44866	29711	24133	19602		82	25629	228,77	88135
	20,00	50202	46457	45659	45056	29855	24250	19697		70	26989	206,06	84609
	21,95	49268	46410	45531	44866	28997	23553	19131		64	26957	187,50	88135
	25,67	50202	46457	45659	45056	29855	24250	19697		55	29086	173,05	84609
	30,46	50202	46457	45659	45056	29855	24250	19697		46	30619	153,50	84609
	37,38	46515	42430	41734	41207	29427	23902	19415	37	32093	131,09	80093	
3	56,00	49268	46410	45531	42874	26455	21488	17454	1400	25	32570	90,70	88135
	61,59	49268	46410	45531	44866	28275	22966	18654		23	35817	90,70	88135
	72,00	50202	46457	45659	45056	29855	24250	19697		19	39634	85,85	84609
	79,04	49268	46410	45531	44866	28997	23553	19131		18	39588	78,11	88135
	85,00	50202	46457	45659	45056	29855	24250	19697		16	41658	76,43	84609
	92,40	50202	46457	45659	45056	29855	24250	19697		15	42714	72,09	84609
	106,67	50202	46457	45659	45056	29855	24250	19697		13	44594	65,20	84609
	109,66	50202	46457	45659	45056	29855	24250	19697		13	44843	63,77	84609
	124,00	50202	46457	45659	45056	29839	24237	19687		11	44950	56,53	84609
	136,89	50202	46457	45659	45056	29855	24250	19697		10	45036	51,31	84609
	150,00	47225	45205	42534	40513	29483	23948	19452		9,3	40714	42,33	84609
	159,13	50202	46457	45659	45056	29855	24250	19697		8,8	45167	44,26	84609
	184,09	46515	42430	41734	41207	29427	23902	19415		7,6	41415	35,08	80093
	192,50	50202	46457	45659	45056	29855	24250	19697		7,3	45333	36,73	84609
	199,38	46515	42430	41734	41207	29427	23902	19415		7,0	41476	32,44	80093
	228,46	50202	46457	45659	45056	29855	24250	19697		6,1	45482	31,05	84609
236,25	46515	42430	41734	41207	29427	23902	19415	5,9	41605	27,46	80093		
280,38	46515	42430	41734	41207	29427	23902	19415	5,0	41735	23,21	80093		
4	214,32	49268	46410	45531	44866	28275	22966	18654	1400	6,5	43000	31,97	88135
	250,56	50202	46457	45659	45056	29855	24250	19697		5,6	43500	27,66	84609
	295,80	50202	46457	45659	45056	29855	24250	19697		4,7	43500	23,43	84609
	306,95	50202	46457	45659	45056	29855	24250	19697		4,6	43500	22,58	84609
	321,55	50202	46457	45659	45056	29855	24250	19697		4,4	43500	21,56	84609
	362,37	50202	46457	45659	45056	29855	24250	19697		3,9	44000	19,35	84609
	415,38	50202	46457	45659	45056	29855	24250	19697		3,4	44000	16,88	84609
	454,74	50202	46457	45659	45056	29855	24250	19697		3,1	44000	15,42	84609
	518,40	50202	46457	45659	45056	29855	24250	19697		2,7	44100	13,56	84609
	553,78	50202	46457	45659	45056	29855	24250	19697		2,5	44100	12,69	84609
	611,92	50202	46457	45659	45056	29855	24250	19697		2,3	44200	11,51	84609
	715,38	50202	46457	45659	45056	29839	24237	19687		2,0	44200	9,85	84609
	820,66	50202	46457	45659	45056	29855	24250	19697		1,7	45000	8,74	84609
	918,08	50202	46457	45659	45056	29855	24250	19697		1,5	45000	7,81	84609
	1007,17	46515	42430	41734	41207	29427	23902	19415		1,4	46000	7,28	80093
	1110,58	50202	46457	45659	45056	29855	24250	19697		1,3	46500	6,67	84609
	1318,05	50202	46457	45659	45056	29855	24250	19697		1,1	47500	5,74	84609
	1386,00	50202	46457	45659	45056	29855	24250	19697		1,0	48800	5,61	84609
	1644,92	50202	46457	45659	45056	29855	24250	19697		0,9	48000	4,65	84609
1701,00	46515	42430	41734	41207	29427	23902	19415	0,8	45000	4,22	80093		
2018,77	46515	42430	41734	41207	29427	23902	19415	0,7	46000	3,63	80093		

P _{TN}	PS PSB	S-SB-SU FS-FSB
4201	91.3	47.9
4202	56.1	37.5
4203	37.0	26.1
4204	29.3	21.2

1.2 Prestazioni

1.2 Performances

1.2 Leistungen

		n ₂ X h							10000 Hours Life				T _{max} [Nm]
		T _N [Nm]							n ₁ [rpm]	n ₂ [rpm]	T _N [Nm]	P ₁ [kW]	
Stadio Stage Stufe	ir	10000	20000	50000	100000	500000	1000000	2000000					
4	141,65	49268	46410	45531	42874	26455	21488	17454	1400	9,9	44878	51,60	88135
	155,78	49268	46410	45531	44866	28275	22966	18654		9,0	44968	47,02	88135
	182,12	50202	46457	45659	45056	29855	24250	19697		7,7	45284	40,50	84609
	199,92	49268	46410	45531	44866	28997	23553	19131		7,0	45208	36,83	88135
	233,72	50202	46457	45659	45056	29855	24250	19697		6,0	45502	31,71	84609
	277,38	50202	46457	45659	45056	29855	24250	19697		5,0	45651	26,81	84609
	313,65	50202	46457	45659	45056	29839	24237	19687		4,5	45758	23,76	84609
	346,25	50202	46457	45659	45056	29855	24250	19697		4,0	45844	21,57	84609
	402,51	50202	46457	45659	45056	29855	24250	19697		3,5	45975	18,60	84609
	456,92	50202	46457	45659	45056	29855	24250	19697		3,1	46086	16,43	84609
	486,91	50202	46457	45659	45056	29855	24250	19697		2,9	46141	15,44	84609
	577,87	50202	46457	45659	45056	29855	24250	19697		2,4	46290	13,05	84609
	663,06	50202	46457	45659	45056	29855	24250	19697		2,1	46410	11,40	84609
	755,45	50202	46457	45659	45056	29855	24250	19697		1,9	46523	10,03	84609
	802,08	50202	46457	45659	45056	29855	24250	19697		1,7	46576	9,46	84609
	943,01	50202	46457	45659	45056	29855	24250	19697		1,5	48623	8,40	84609
	1096,25	50202	46457	45659	45056	29855	24250	19697		1,3	48582	7,22	84609
	1326,11	50202	46457	45659	45056	29855	24250	19697		1,1	49776	6,11	84609
	1573,85	50202	46457	45659	45056	29855	24250	19697		0,9	51122	5,29	84609
	1931,54	46515	42430	41734	41207	29427	23902	19415		0,7	47973	4,05	80093

B

P_{TN}	PS PSB	S-SB-SU FS-FSB
4204	25.5	19.6



1.2 Prestazioni

1.2 Performances

1.2 Leistungen

EX 	n ₂ X h								10000 Hours Life				T _{max} [Nm]
	Stadio Stage Stufe	ir	10000	20000	50000	100000	500000	1000000	2000000	n ₁ [rpm]	n ₂ [rpm]	T _N [Nm]	
1	4,18	66723	62817	61580	60644	38889	31588	25657	1000	335	24318	869,89	123333
	4,89	67095	61932	60499	59747	38401	31191	25335		286	25165	769,99	119130
	6,00	60279	57012	55884	55030	37694	30617	24869		233	26267	654,87	116505
2	15,16	66723	62817	61580	60644	38889	31588	25657	1400	92	32351	325,88	123333
	16,73	66723	62817	61580	60644	38889	31588	25657		84	33320	304,18	123333
	19,56	67095	61932	60499	59747	38401	31191	25335		72	34481	269,25	119130
	21,75	66723	62817	61580	60644	38889	31588	25657		64	36049	253,15	123333
	26,14	66723	62817	61580	60644	38889	31588	25657		54	38094	222,57	123333
	30,56	67095	61932	60499	59747	38401	31191	25335		46	39420	197,01	119130
	37,50	60279	57012	55884	55030	37694	30617	24869	37	41146	167,55	116505	
3	53,06	66723	62817	61580	51235	31614	25678	20857	1400	26	38296	112,57	123333
	58,55	66723	62817	61580	54890	33869	27510	22345		24	42257	112,57	123333
	68,44	67095	61932	60499	59747	37783	30689	24927		20	49402	112,57	119130
	76,11	66723	62817	61580	60644	38889	31588	25657		18	52494	107,57	123333
	80,67	67095	61932	60499	59747	37476	30440	24725		17	51477	99,52	119130
	89,70	66723	62817	61580	60644	38889	31588	25657		16	55147	95,88	123333
	99,00	60279	57012	55884	55030	37694	30617	24869		14	53083	83,62	116505
	107,81	66723	62817	61580	60644	38889	31588	25657		13	58275	84,30	123333
	126,04	67095	61932	60499	59747	38401	31191	25335		11	59633	73,79	119130
	135,04	66723	62817	61580	60644	38889	31588	25657		10	60595	69,98	123333
	152,53	67095	61932	60499	59747	38401	31191	25335		9,2	59840	61,18	119130
	157,87	67095	61932	60499	59747	38401	31191	25335		8,9	59877	59,15	119130
	174,00	60279	57012	55884	55030	37694	30617	24869		8,0	55297	49,56	116505
	184,31	67095	61932	60499	59747	38401	31191	25335		7,6	60045	50,81	119130
	189,49	66723	62817	61580	60644	38889	31588	25657		7,4	61053	50,25	123333
221,53	67095	61932	60499	59747	38401	31191	25335	6,3	60245	42,41	119130		
271,88	60279	57012	55884	55030	37694	30617	24869	5,1	55847	32,04	116505		
4	246,40	67095	61932	60499	59747	37783	30689	24927	1400	5,7	60000	38,80	119130
	273,99	67095	61932	60499	59747	37476	30440	24725		5,1	60500	35,18	119130
	323,46	67095	61932	60499	59747	37476	30440	24725		4,3	61000	30,05	119130
	365,04	67095	61932	60499	59747	37783	30689	24927		3,8	61000	26,63	119130
	405,92	67095	61932	60499	59747	37476	30440	24725		3,4	61500	24,14	119130
	453,75	67095	61932	60499	59747	38401	31191	25335		3,1	61700	21,67	119130
	535,68	67095	61932	60499	59747	38401	31191	25335		2,6	61900	18,41	119130
	573,91	66723	62817	61580	60644	38889	31588	25657		2,4	62500	17,35	123333
	648,27	67095	61932	60499	59747	38401	31191	25335		2,2	62000	15,24	119130
	720,20	66723	62817	61580	60644	38889	31588	25657		1,9	63000	13,94	123333
	805,33	66723	62817	61580	60644	38889	31588	25657		1,7	63500	12,56	123333
	945,71	67095	61932	60499	59747	38401	31191	25335		1,5	63500	10,70	119130
	1010,61	66723	62817	61580	60644	38889	31588	25657		1,4	63500	10,01	123333
	1144,00	67095	61932	60499	59747	38401	31191	25335		1,2	64000	8,91	119130
	1305,00	60279	57012	55884	55030	37694	30617	24869		1,1	60000	7,33	116505
	1375,00	67095	61932	60499	59747	38401	31191	25335		1,0	67000	7,76	119130
	1421,16	66723	62817	61580	60644	38889	31588	25657		1,0	66800	7,49	123333
	1661,46	67095	61932	60499	59747	38401	31191	25335		0,8	68000	6,52	119130
2039,06	60279	57012	55884	55030	37694	30617	24869	0,7	62000	4,85	116505		

P _{TN}	PS PSB	S-SB-SU FS-FSB
6501	117.0	65.2
6502	73.5	51.3
6503	48.8	35.8
6504	38.6	28.8

1.2 Prestazioni

1.2 Performances

1.2 Leistungen

		n ₂ X h							10000 Hours Life				T _{max} [Nm]
		T _N [Nm]							n ₁ [rpm]	n ₂ [rpm]	T _N [Nm]	P ₁ [kW]	
Stadio Stage Stufe	ir	10000	20000	50000	100000	500000	1000000	2000000					
4	134,20	66723	62817	61580	51235	31614	25678	20857	1400	10,4	50589	61,40	123333
	148,09	66723	62817	61580	54890	33869	27510	22345		9,5	55822	61,40	123333
	173,12	67095	61932	60499	59747	37783	30689	24927		8,1	59977	56,43	119130
	192,51	66723	62817	61580	60644	38889	31588	25657		7,3	61074	51,68	123333
	226,89	66723	62817	61580	60644	38889	31588	25657		6,2	61296	44,01	123333
	272,70	66723	62817	61580	60644	38889	31588	25657		5,1	61544	36,76	123333
	318,81	67095	61932	60499	59747	38401	31191	25335		4,4	60640	30,98	119130
	341,57	66723	62817	61580	60644	38889	31588	25657		4,1	61848	29,49	123333
	399,32	67095	61932	60499	59747	38401	31191	25335		3,5	60884	24,84	119130
	466,20	67095	61932	60499	59747	38401	31191	25335		3,0	61052	21,33	119130
	525,17	67095	61932	60499	59747	38401	31191	25335		2,7	61181	18,98	119130
	560,33	67095	61932	60499	59747	38401	31191	25335		2,5	61273	17,81	119130
	657,79	67095	61932	60499	59747	38401	31191	25335		2,1	61640	15,26	119130
	767,96	67095	61932	60499	59747	38401	31191	25335		1,8	62472	13,25	119130
	923,03	67095	61932	60499	59747	38401	31191	25335		1,5	63787	11,26	119130
	1087,55	67095	61932	60499	59747	38401	31191	25335		1,3	65087	9,75	119130
	1269,70	67095	61932	60499	59747	38401	31191	25335		1,1	66329	8,51	119130
	1526,08	67095	61932	60499	59747	38401	31191	25335		0,9	67751	7,23	119130
1872,92	60279	57012	55884	55030	37694	30617	24869	0,7	61963	5,39	116505		

B

P_{TN}	PS PSB	S-SB-SU FS-FSB
6504	32.2	25.2



1.2 Prestazioni

1.2 Performances

1.2 Leistungen

EX		$n_2 \times h$							10000 Hours Life				T_{max} [Nm]
Stadio Stage Stufe	ir	10000	20000	50000	100000	500000	1000000	2000000	n_1 [rpm]	n_2 [rpm]	T_N [Nm]	P_1 [kW]	
1	4,18	88361	82056	80656	79597	53235	43240	35122	1000	335	33289	1190,77	171053
	4,89	89324	82360	79855	78791	52013	42248	34316		286	34085	1042,93	162069
	6,00	82807	75822	72518	65903	50855	41307	33552		233	35686	889,71	152542
2	14,72	88361	82056	80656	79597	53235	43240	35122	1400	95	43895	455,37	171053
	16,73	88361	82056	80656	79597	53235	43240	35122		84	45611	416,39	171053
	19,70	88361	82056	80656	79597	53235	43240	35122		71	47903	371,39	171053
	23,03	89324	82360	79855	78791	52013	42248	34316		61	49050	325,28	162069
	28,26	82807	75822	72518	65903	50855	41307	33552		50	50997	275,56	152542
3	51,52	88361	82056	80656	68800	42452	34482	28008	1400	27	50973	154,30	171053
	58,55	88361	82056	80656	75240	46426	37710	30630		24	57924	154,30	171053
	68,94	88361	82056	80656	79597	52052	42279	34341		20	68206	154,30	171053
	81,25	88361	82056	80656	79597	51629	41936	34062		17	71070	136,42	171053
	86,42	88361	82056	80656	72543	44761	36358	29532		16	62769	113,27	171053
	94,99	89324	82360	79855	78791	52013	42248	34316		15	75035	123,20	162069
	101,76	88361	82056	80656	79597	50185	40763	33110		14	73911	113,27	171053
	118,97	89324	82360	79855	78791	52013	42248	34316		12	78541	102,96	162069
	142,80	88361	82056	80656	78176	48621	39492	32078		10	78299	85,51	171053
	166,94	89324	82360	79855	78791	52013	42248	34316		8,4	79061	73,86	162069
	174,00	82807	75822	72518	65903	50855	41307	33552		8,0	67910	60,87	152542
	204,89	82807	75822	72518	65903	50855	41307	33552		6,8	69459	52,87	152542
4	248,17	88361	82056	80656	79597	52052	42279	34341	1400	5,6	81500	52,33	171053
	292,49	88361	82056	80656	79597	51629	41936	34062		4,8	81000	44,13	171053
	341,95	89324	82360	79855	78791	52013	42248	34316		4,1	81000	37,75	162069
	367,67	88361	82056	80656	79597	52052	42279	34341		3,8	81000	35,11	171053
	403,69	89324	82360	79855	78791	52013	42248	34316		3,5	81000	31,97	162069
	433,32	88361	82056	80656	79597	51629	41936	34062		3,2	81000	29,79	171053
	505,63	89324	82360	79855	78791	52013	42248	34316		2,8	81000	25,53	162069
	542,74	88361	82056	80656	79597	50185	40763	33110		2,6	82000	24,07	171053
	609,36	88361	82056	80656	79597	51629	41936	34062		2,3	82000	21,44	171053
	634,51	89324	82360	79855	78791	52013	42248	34316		2,2	82000	20,59	162069
	737,62	89324	82360	79855	78791	52013	42248	34316		1,9	83000	17,93	162069
	763,23	88361	82056	80656	79597	50185	40763	33110		1,8	84000	17,54	171053
	892,28	89324	82360	79855	78791	52013	42248	34316		1,6	85000	15,18	162069
	928,00	82807	75822	72518	65903	50855	41307	33552		1,5	82000	14,08	152542
	1070,99	88361	82056	80656	78176	48621	39492	32078		1,3	86000	12,80	171053
	1252,08	89324	82360	79855	78791	52013	42248	34316		1,1	88000	11,20	162069
	1305,00	82807	82056	72518	65903	50855	41307	33552		1,1	82500	10,07	152542
	1536,64	82807	75822	72518	65903	50855	41307	33552		0,9	83000	8,61	152542

P_{TN}	PS PSB	S-SB-SU FS-FSB
8501	159.9	80.1
8502	91.6	57.4
8503	59.8	39.9
8504	47.2	32.2

1.2 Prestazioni

1.2 Performances

1.2 Leistungen

		n ₂ X h							10000 Hours Life				T _{max} [Nm]
		T _N [Nm]							n ₁ [rpm]	n ₂ [rpm]	T _N [Nm]	P ₁ [kW]	
Stadio Stage Stufe	ir	10000	20000	50000	100000	500000	1000000	2000000					
4	130,32	88361	82056	80656	68800	42452	34482	28008	1400	10,7	67336	84,17	171053
	148,09	88361	82056	80656	75240	46426	37710	30630		9,5	76519	84,17	171053
	174,37	88361	82056	80656	79597	52052	42279	34341		8,0	79933	74,67	171053
	205,51	88361	82056	80656	79597	51629	41936	34062		6,8	80184	63,55	171053
	240,26	89324	82360	79855	78791	52013	42248	34316		5,8	79620	53,98	162069
	300,93	89324	82360	79855	78791	52013	42248	34316		4,7	79965	43,28	162069
	361,20	88361	82056	80656	78176	48621	39492	32078		3,9	81045	36,55	171053
	422,27	89324	82360	79855	78791	52013	42248	34316		3,3	80465	31,04	162069
	495,71	89324	82360	79855	78791	52013	42248	34316		2,8	80731	26,53	162069
	594,99	88361	82056	80656	78176	48621	39492	32078		2,4	81808	22,40	171053
	654,34	89324	82360	79855	78791	52013	42248	34316		2,1	81796	20,36	162069
	695,60	89324	82360	79855	78791	52013	42248	34316		2,0	82305	19,27	162069
	819,58	89324	82360	79855	78791	52013	42248	34316		1,7	83863	16,67	162069
	853,69	82807	75822	72518	65903	50855	41307	33552		1,6	76132	14,53	152542
	983,72	88361	82056	80656	78176	48621	39492	32078		1,4	82576	13,67	171053
	1150,05	89324	82360	79855	78791	52013	42248	34316		1,2	87375	12,38	162069
	1411,43	82807	75822	72518	65903	50855	41307	33552		1,0	83035	9,58	152542

B

P _{TN}	PS PSB	S-SB-SU FS-FSB
8504	38.5	27.6

1.2 Prestazioni

1.2 Performances

1.2 Leistungen

EX		n ₂ X h							10000 Hours Life				T _{max} [Nm]
Stadio Stage Stufe	ir	10000	20000	50000	100000	500000	1000000	2000000	n ₁ [rpm]	n ₂ [rpm]	T _N [Nm]	P ₁ [kW]	
1	4,18	121725	112859	110881	109386	84857	68926	55985	500	335	65328	2336,86	274074
	4,89	127834	118564	114734	113239	83351	67702	54991		286	67247	2057,60	255357
	6,00	93419	85995	84359	83122	73747	66640	54129		233	70387	1754,85	210435
2	16,91	121725	112859	110881	109386	69788	56685	46043	1000	83	66360	599,29	274074
	19,77	127834	118564	114734	113239	77852	63235	51363		71	77580	599,29	255357
	25,02	127834	118564	114734	113239	76328	61997	50358		56	81631	498,23	255357
	29,33	127834	118564	114734	113239	74811	60765	49357		48	83920	436,87	255357
	36,00	127834	118564	114734	109842	74066	60160	48865		39	88349	374,76	245084
	44,18	93419	85995	84359	83122	73747	69433	56397		32	77089	266,44	210435
3	59,18	121725	112859	107336	87184	53795	43695	35492	1400	24	67337	177,44	274074
	69,19	127834	118564	114734	97259	60012	48745	39593		20	78723	177,44	255357
	74,90	121725	112859	110881	102815	63440	51530	41855		19	85225	177,44	274074
	87,57	127834	118564	114734	113239	70771	57484	46692		16	99636	177,44	255357
	102,67	127834	118564	114734	113239	74811	60765	49357		14	110470	167,81	255357
	121,00	127834	118564	114734	113239	74811	60765	49357		12	112925	145,55	255357
	129,27	127834	118564	114734	110584	68234	55423	45018		11	107969	130,26	255357
	151,56	127834	118564	114734	113239	74811	60765	49357		9,2	113410	116,70	255357
	176,00	127834	118564	114734	113239	74591	60587	49212		8,0	113733	100,78	255357
	212,67	127834	118564	114734	112730	73893	60020	48751		6,6	114141	83,70	255357
	261,00	127834	118564	114734	109842	74066	60160	48865		5,4	114381	68,35	245084
	320,32	93419	85995	84359	83122	73747	69433	56397		4,4	84599	41,19	210435
4	249,08	127834	118564	114734	97259	60012	48745	39593	1400	5,6	114482	73,24	255357
	293,56	127834	118564	114734	96469	59525	48349	39272		4,8	114836	62,33	255357
	315,25	127834	118564	114734	113239	70771	57484	46692		4,4	114990	58,12	255357
	369,60	127834	118564	114734	113239	74811	60765	49357		3,8	115333	49,72	255357
	398,06	121725	112859	110881	99129	61166	49682	40354		3,5	106324	42,56	274074
	435,60	127834	118564	114734	113239	74811	60765	49357		3,2	115688	42,32	255357
	514,25	127834	118564	114734	113239	74811	60765	49357		2,7	116046	35,96	255357
	547,56	127834	118564	114734	113239	74811	60765	49357		2,6	116181	33,81	255357
	636,53	127834	118564	114734	113239	74811	60765	49357		2,2	117384	29,38	255357
	656,76	127834	118564	114734	113239	70771	57484	46692		2,1	117760	28,57	255357
	750,20	127834	118564	114734	113239	74811	60765	49357		1,9	119480	25,38	255357
	808,30	127834	118564	114734	113239	74811	60765	49357		1,7	120499	23,75	255357
	938,67	127834	118564	114734	113239	74591	60587	49212		1,5	122579	20,81	255357
	1091,20	127834	118564	114734	113239	74591	60587	49212		1,3	124643	18,20	255357
	1318,53	127834	118564	114734	112730	73893	60020	48751		1,1	127069	15,36	255357
	1595,00	127834	118564	114734	112730	73893	60020	48751		0,88	129351	12,92	255357
	1957,50	127834	118564	114734	109842	74066	60160	48865		0,72	131497	10,70	245084
	2402,39	93419	85995	84359	83122	73747	69433	56397		0,58	98887	6,56	210435

P _{TN}	S-SB-SU FS-FSB
12001	99,7
12002	73,1
12003	51,4
12004	40,9

1.2 Prestazioni

1.2 Performances

1.2 Leistungen

 EXB Stadio Stage Stufe		n ₂ X h							10000 Hours Life				T _{max} [Nm]
		T _N [Nm]							n ₁ [rpm]	n ₂ [rpm]	T _N [Nm]	P ₁ [kW]	
ir	10000	20000	50000	100000	500000	1000000	2000000						
4	149,70	121725	112859	107336	87184	53795	43695	35492	1400	9,4	88953	96,79	274074
	175,01	127834	118564	114734	97259	60012	48745	39593		8,0	103993	96,79	255357
	189,46	121725	112859	110881	102815	63440	51530	41855		7,4	104799	90,10	274074
	221,50	127834	118564	114734	113239	70771	57484	46692		6,3	114229	84,00	255357
	259,69	127834	118564	114734	113239	74811	60765	49357		5,4	114572	71,86	255357
	306,06	127834	118564	114734	113239	74811	60765	49357		4,6	114926	61,16	255357
	383,35	127834	118564	114734	113239	74811	60765	49357		3,7	115412	49,04	255357
	445,18	127834	118564	114734	113239	74591	60587	49212		3,1	115734	42,35	255357
	504,17	127834	118564	114734	113239	74811	60765	49357		2,8	116000	37,48	255357
	537,92	127834	118564	114734	112730	73893	60020	48751		2,6	116143	35,17	255357
	631,48	127834	118564	114734	113239	74811	60765	49357		2,2	117291	30,25	255357
	733,33	127834	118564	114734	113239	74591	60587	49212		1,9	119175	26,47	255357
	833,56	127834	118564	114734	113239	74811	60765	49357		1,7	120925	23,63	255357
	1044,05	127834	118564	114734	113239	74811	60765	49357		1,3	124045	19,35	255357
	1212,44	127834	118564	114734	112730	73893	60020	48751		1,2	126034	16,93	255357
	1465,04	127834	118564	114734	112730	73893	60020	48751		1,0	128375	14,27	255357
	1798,00	127834	118564	114734	109842	74066	60160	48865		0,8	130642	11,84	245084
	2206,64	93419	85995	84359	83122	73747	69433	56397		0,6	98360	7,26	210435

B

P_{TN}	S-SB-SU
12004	FS-FSB
	33,9

